

Rodigas[®]
SRL 

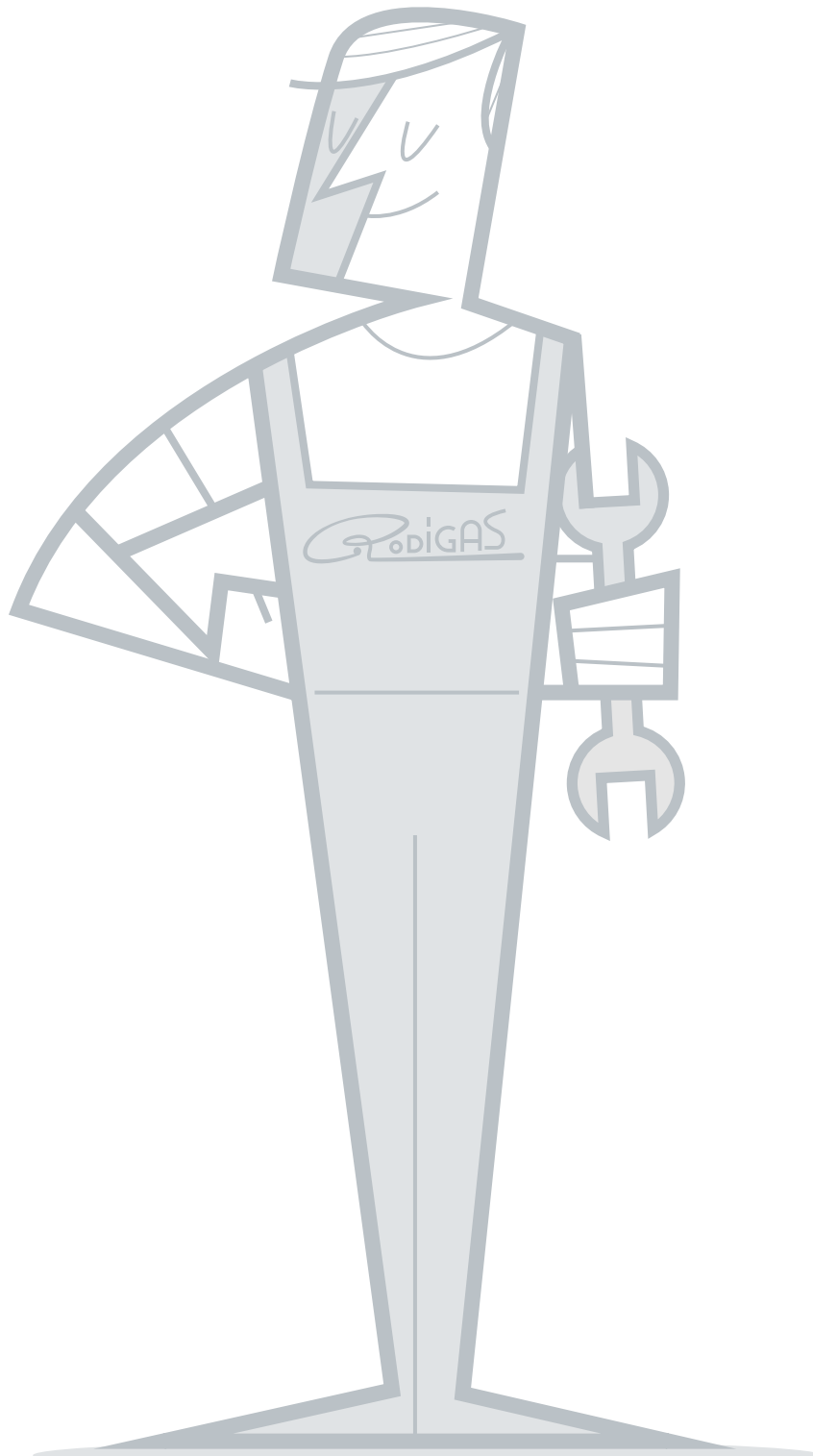



**Flexibility and innovation
have been our beating heart
for 60 years.**

**Flessibilità e innovazione
sono il nostro cuore pulsante,
da 60 anni.**

Rodigas's story is the story of a company that, since its establishment, has been able to read and interpret the changes in society, anticipate market evolutions and to offer more solutions in step with the times. The ability to adapt to change and technological innovation are the keys to the success of our company, which today operates globally in the fields of air conditioning, photovoltaics, and fall protection systems in over 40 countries around the world.

La storia di Rodigas è la storia di un'azienda che, fin dalla sua fondazione, ha saputo leggere e interpretare i cambiamenti della società, riuscendo ad anticipare le evoluzioni del mercato e a offrire soluzioni sempre al passo con i tempi. Capacità di adattamento ai cambiamenti e innovazione tecnologica sono le chiavi del successo della nostra azienda che, oggi, opera a livello mondiale nei settori dell'impiantistica di condizionamento, del fotovoltaico e dei sistemi anticaduta, in oltre 40 paesi nel mondo.

“My company has grown following
the changes in society.
This flexibility has marked our
success over time.”

“La mia azienda è cresciuta seguendo
i cambiamenti della società.
Questa flessibilità ha segnato il nostro
successo nel tempo.”

Dino Roverato
Rodigas founder

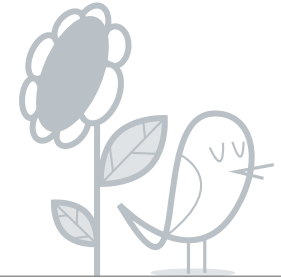
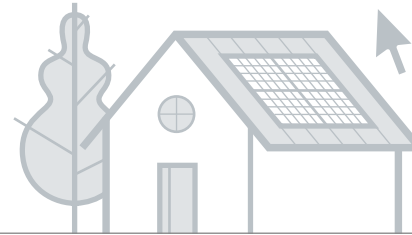
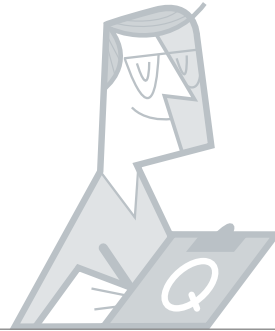

Page

06

08

10

12

THE STORY OF RODIGAS

A story of far-sighted choices that we never tire of telling.

LA STORIA DI RODIGAS

Una storia di scelte lungimiranti che non ci stanchiamo mai di raccontare.

OUR CERTIFICATIONS

Certified products and processes are the best guarantee of quality we can offer you.

LE NOSTRE CERTIFICAZIONI

Prodotti e processi certificati sono la migliore garanzia di qualità che possiamo offrirvi.

BIM PRODUCT MODELS

A state-of-the-art service designed and built to simplify the work of designers.

MODELLI BIM DEI PRODOTTI

Un servizio all'avanguardia pensato e realizzato per semplificare il lavoro dei progettisti.

ENVIRONMENTAL RESPONSIBILITY

We produce conscientiously, respecting the environment and thinking about a more sustainable future.

RESPONSABILITÀ AMBIENTALE

Produciamo con coscienza, rispettando l'ambiente e pensando a un futuro più sostenibile.

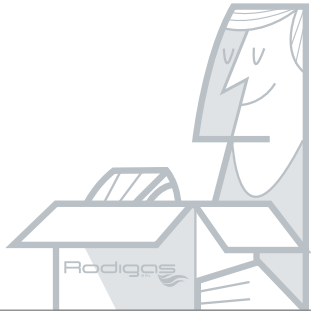

14

OUR PRODUCTS

Certified products and processes are the best guarantee of quality we can offer you.

I NOSTRI PRODOTTI

Prodotti e processi certificati sono la migliore garanzia di qualità che possiamo offrirvi.

22	Sliding brackets Mensole scorrevoli
38	Folding brackets Mensole pieghevoli
46	Welded brackets Mensole saldate
60	Roof brackets Mensole da tetto
64	Special brackets Mensole speciali
72	Floor supports Supporti pavimento
80	Vibration dampers Antivibranti
84	Condensate drainage set Scarico condensa
96	Ducts Canaline
102	Accessories Accessori
108	Special packaging Imballi speciali

1965

Boilers and burners production
Produzione di caldaie e bruciatori

1965 is the year that marks the transition from an almost domestic production to industrialisation of the processes for manufacturing boilers and burners



Changing of the company towards the engineering field
Prima conversione dell'azienda

An increasingly saturated market led the company to rapidly address the metal and mechanical sector. Making use of highly skilled labour, Rodigas specialised in the production of dies for sheet metal forming. "the choice of following the changes in society led me, and my wife Elsa, who has always been at my side taking care of the administrative part, to focus on the production of innovative articles that combine quality and high productivity"



1970

1958

Foundation of "Rodigas of Roverato Dino"
Fondazione di "Rodigas di Roverato Dino"



With the arrival of natural gas in Padua, with great insight Dino Roverato decided to start manufacturing burners for converting old wood and coal stoves and cookers into modern gas cookers

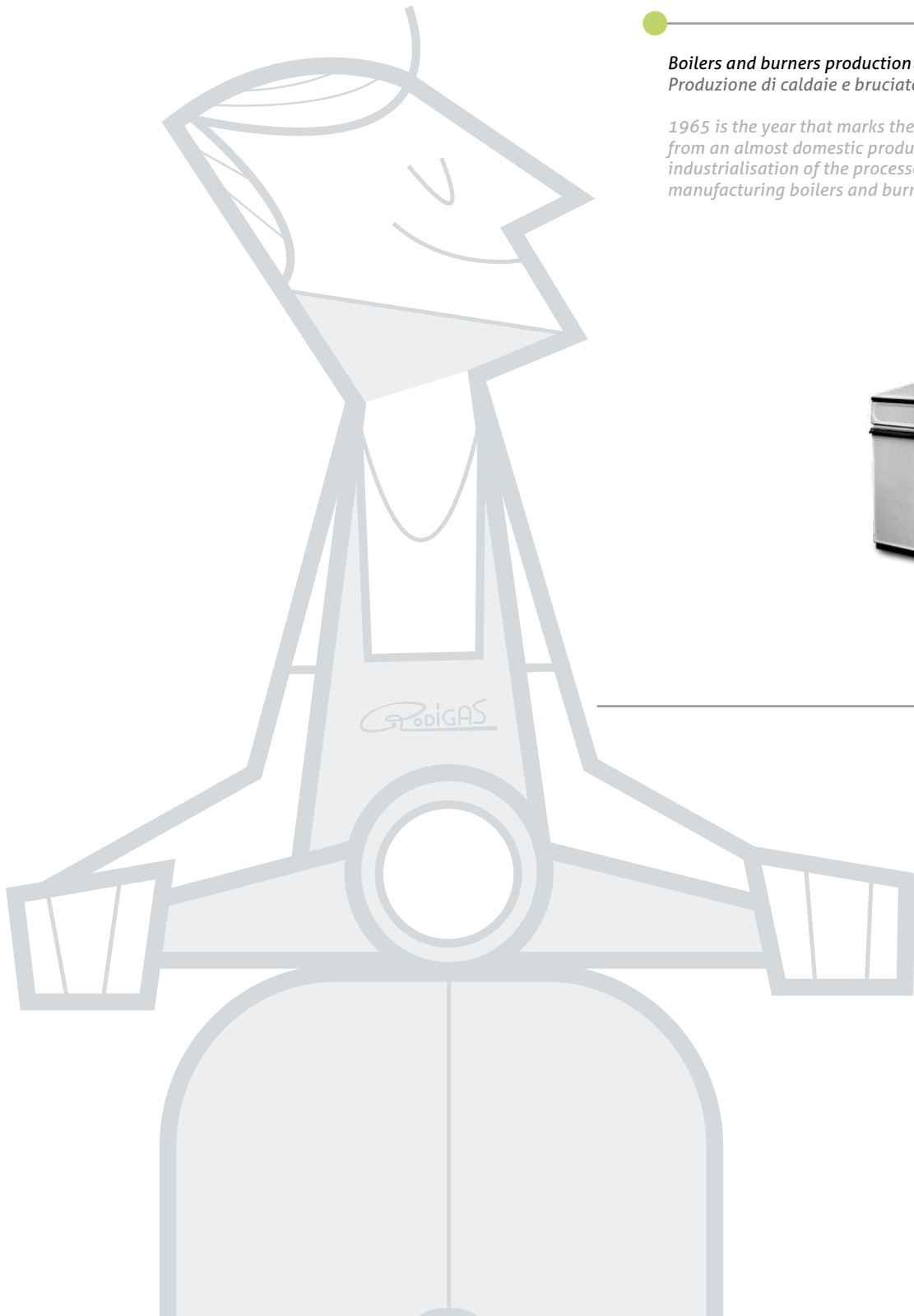

2000

*Rodigas of Roverato Dino becomes Rodigas srl
Rodigas di Roverato Dino diventa Rodigas srl*

RODIGAS



The company is a leading player with a courageous entrepreneurial choice. While many companies are beginning to relocate, Rodigas has acquired the very latest technologies for working sheet metal in order to manufacture rapidly and competitively certified articles manufactured entirely in Padua.

"relocation is an affront to the territory and the people who have given so much to allow us to grow over the years. Impoverishing an area to increase profits is totally extraneous to the corporate philosophy of Rodigas".



2011

*Enlargement to fall-arrest system production
Allargamento produzione a Linee Vita*



2018

*At 60 years since the foundation of partnerships in over 40 countries around the world.
A 60 anni dalla fondazione partnership in oltre 40 paesi nel mondo.*



*Production of air-conditioning mounting systems
Seconda conversione dell'azienda*



2007

*Enlargement to photovoltaic mounting systems production
Inizio della produzione ai sistemi di fissaggio per il fotovoltaico*

Another big energy change involves the country: the arrival of photovoltaic systems

"Rodigas has always shown great flexibility in addressing the energy evolution. Thus, with the arrival of renewable energies, we decided to extend production to fixing systems for the photovoltaic sector"

The gradual shortage of specialised labour in Italy led the firm to change its production to fixed fastening systems for air conditioning, which has been and still is the recent story of Rodigas in Italy and abroad

1990



Certified products and processes are the best guarantee of quality we can offer you.

Prodotti e processi certificati sono la migliore garanzia di qualità che possiamo offrirvi.

The use of the most advanced sheet metal processing technology allows us not only to produce quickly and competitively but also and above all to offer certified products according to the most restrictive industry regulations. Thanks to the high level of automation of our production processes, we can also guarantee the total traceability of the manufactured parts. The TÜV standard we apply for the certification of our brackets provides verification loads three times higher than the stated range, with total quality assurance.

L'impiego delle più avanzate tecnologie per la trasformazione della lamiera ci consente non soltanto di produrre in tempi rapidi e concorrenziali, ma anche e soprattutto di offrire prodotti certificati secondo le più restrittive normative di settore. Grazie all'alto livello di automazione dei nostri processi produttivi, inoltre, possiamo assicurare la totale rintracciabilità dei pezzi prodotti. Lo standard TÜV che applichiamo per la certificazione delle nostre staffe prevede carichi di verifica tre volte superiori alla portata dichiarata, a totale garanzia di qualità.

Production capacity

Capacità produttiva

4.800 in day

 = 100 pairs / coppie



Guaranteed resistance

Resistenza garantita

420 Kg

140 Kg

actual carrying capacity

portata effettiva

declared carrying capacity

portata dichiarata



To respond positively to increasingly demanding market demands and to protect our customers and consumers, we have chosen to certify our products by leading internationally recognized organizations such as TÜV Rheinland, TÜV Sud and Vincotte.

Specifically, we have successfully achieved the following quality awards:

- ISO 9001: 2015 for the certification of production processes
- ISO 14001: 2004 for environmental management of production
- Welding processes and welders certified by the notified body Vincotte
- Certificate of delivery and test reports issued by TUV Sud

Per rispondere concretamente alle sempre più esigenti richieste del mercato e per tutelare i nostri clienti e i consumatori, abbiamo scelto di far certificare i nostri prodotti dai principali enti internazionalmente riconosciuti, quali TÜV Rheinland, TÜV Sud e Vincotte.

Nello specifico, abbiamo ottenuto con successo i seguenti riconoscimenti di qualità:

- ISO 9001:2015 per la certificazione dei processi produttivi
- ISO 14001:2004 per la gestione ambientale della produzione
- Processi di saldatura e saldatori certificati dal ente notificato Vincotte
- Certificati di portata e test report emessi dal TUV Sud



Management System
ISO 9001:2008
www.tuv.com
ID: 9105073334



Management System
ISO 14001:2004
www.tuv.com
ID: 9105073334



BIM MODELING

Our technical and innovative approach allows us to always align with the most modern design methodologies.

Il nostro approccio tecnico e innovativo ci consente di essere sempre allineati alle più moderne metodologie di progettazione.

For us at Rodigas, service is always the first and most important product we offer to our customers. That is why we are concerned about offering highly professional solutions for technical studies and designers who are more responsive to new technology solutions. This is a brilliant example of our Building Information Modeling Libraries (BIM), available to all professionals who want to include Rodigas products for conditioning, photovoltaics and fall protection in their projects.

Per noi di Rodigas, il servizio è sempre il primo e più importante prodotto che offriamo ai nostri clienti. È per questa ragione che ci preoccupiamo di proporre soluzioni di altissima professionalità anche per gli studi tecnici e i progettisti più attenti alle nuove soluzioni tecnologiche. Ne sono un esempio eclatante le nostre librerie BIM (Building Information Modeling), a disposizione di tutti i professionisti che desiderino inserire nei loro progetti i prodotti Rodigas per il condizionamento, il fotovoltaico e l'anticaduta.



Airconditioning bracket
Mensole per condizionatori

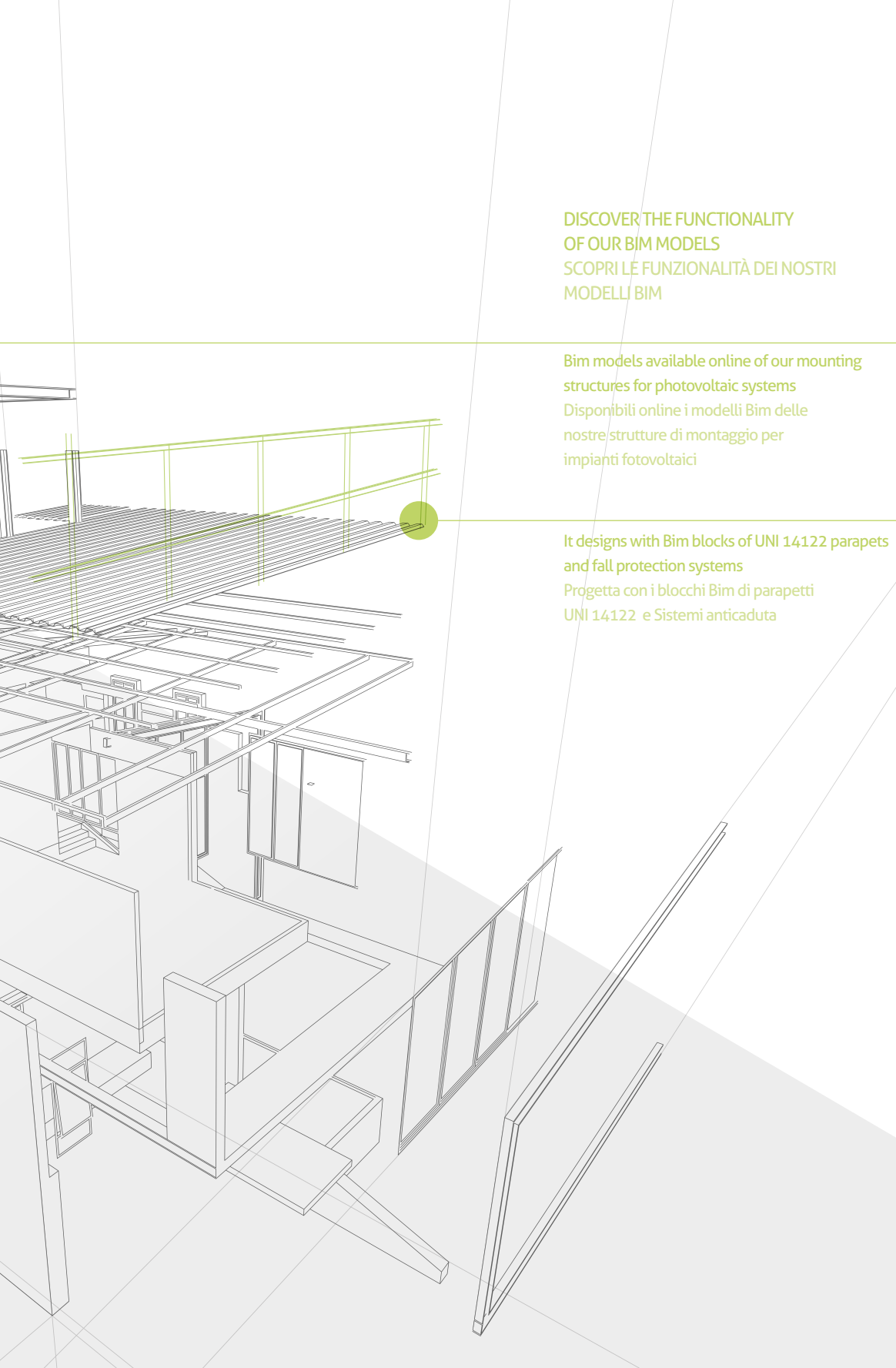

DISCOVER THE FUNCTIONALITY
OF OUR BIM MODELS
SCOPRI LE FUNZIONALITÀ DEI NOSTRI
MODELLI BIM

Bim models available online of our mounting
structures for photovoltaic systems
Disponibili online i modelli Bim delle
nostre strutture di montaggio per
impianti fotovoltaici

It designs with Bim blocks of UNI 14122 parapets
and fall protection systems
Progetta con i blocchi Bim di parapetti
UNI 14122 e Sistemi anticaduta

TRAINING

Rodigas organizes training courses
for all professionals, whether they are
installers or designers: it is always up to
date on our training offer.

Rodigas organizza corsi di formazione per tutti i professionisti,
siano essi installatori o progettisti: resta sempre aggiornato sulla
nostra offerta formativa.

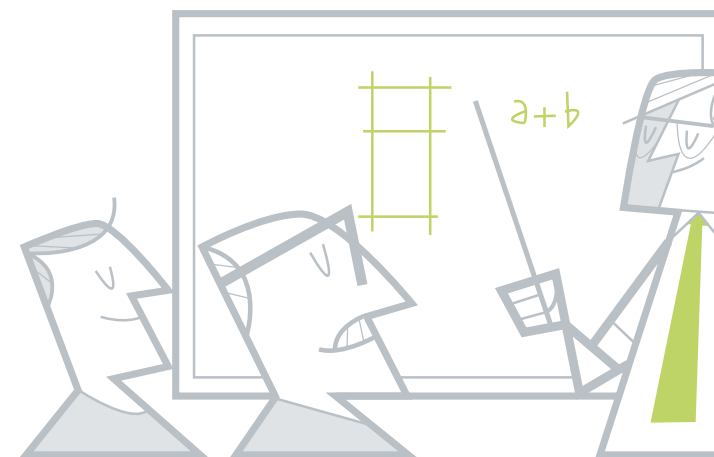

Training is a fundamental tool for acquiring more knowledge and skills
that can be easily spent in an environment characterized by substan-
tial and continuous changes.

La formazione è uno strumento fondamentale per acquisire maggiori
conoscenze e competenze immediatamente spendibili in un ambien-
te contraddistinto da cambiamenti sostanziali e continui.

Responsible and efficient choices with respect to the environment.

Scelte responsabili ed efficienti nel rispetto dell'ambiente.

100%

self-produced energy

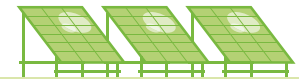

Photovoltaic

The photovoltaic systems installed on the roofs of our factories provide us with all the energy needed for production.

Gli impianti fotovoltaici installati sulle coperture dei nostri stabilimenti ci forniscono tutta l'energia necessaria per la produzione.

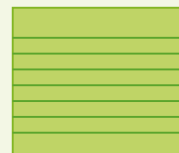
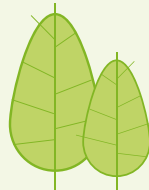

-50%

Electricity consumption

The installation of high efficiency LED lamps has allowed us to reduce the electricity consumption by more than 50% in our plants.

L'installazione di lampade a LED ad alta efficienza, ci ha consentito di ridurre di oltre il 50% il consumo di energia elettrica nei nostri stabilimenti.

Light pollution

Thanks to the replacement of outdoor lighting with modern LED lamps, we have drastically reduced the light pollution produced by our plants.

Grazie alla sostituzione dell'illuminazione esterna con moderni fari a LED direzionali, abbiamo potuto diminuire drasticamente l'inquinamento luminoso prodotto da nostri stabilimenti.

ISO 14001



Management System
ISO 14001:2004



www.tuv.com
ID 9105073334

The Rodigas environmental management system is certified according to the ISO 14001 standard.
Il sistema di gestione ambientale Rodigas è certificato secondo lo standard ISO 14001.

Small and large social projects: a stronger emotion every time.

Piccoli, grandi progetti per il sociale: ogni volta un'emozione più forte.

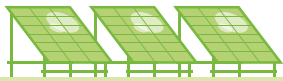

Eternit Free

The roofs of our plants are totally eternit free for the health of our workers and the whole community.

Le coperture dei nostri stabilimenti sono totalmente eternit free per la salute dei nostri lavoratori e di tutta la comunità.

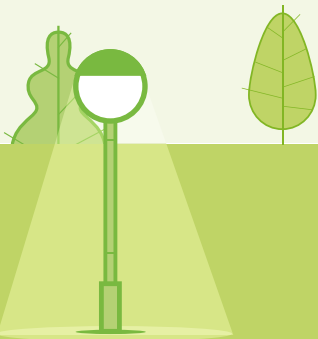

FSC

Paper, cardboard and packaging in the company come exclusively from managed and certified FSC forests.

Carta, cartone e imballi presenti in azienda provengono esclusivamente da foreste gestite e certificate FSC.



Every year we pledge to support development projects in various disadvantaged areas of the world to bring water and light where needed.

Ogni anno ci impegniamo a supporto di progetti di sviluppo in diverse aree disagiate del mondo per portare acqua e luce laddove ce n'è più bisogno.

The quality of certified welds make our welded shelves a synonym for safety.

La qualità delle saldature certificate fanno delle nostre mensole saldate un sinonimo di sicurezza.



We have made "Made in Italy" our philosophy, choosing to invest in advanced technologies for working sheet metal, thereby enabling us to be competitive with a full Italian production range.

Abbiamo fatto del "Made in Italy" la nostra filosofia, scegliendo di investire in avanzate tecnologie per la trasformazione della lamiera, che ci permettono di essere concorrenziali con una produzione integralmente italiana.



WALL FIXING KIT KIT FISSAGGIO A PARETE



OPTIONAL KIT

Optional wall fixing kit.
Kit fissaggio a parete opzionale.

INSULATING WASHERS RONDELLE ISOLANTI



OPTIONAL KIT

Optional insulating washers.
Rondelle isolanti opzionali.

PERMANENT MARKING MARCATURA



MARKING

Products warranted and permanently marked with our name.
Prodotti garantiti e marcati indelebilmente con il nostro nome.

CERTIFIED WELDS SALDATURE CERTIFICATE



FEATURES

Certified welds made in automatic.
Saldature certificate realizzate in automatico.

WE ARE MADE IN ITALY

The use of the most advanced sheet metal processing technology allows us not only to produce quickly and competitively but also and above all to offer certified products according to the most restrictive industry regulations. Thanks to the high level of automation of our production processes, we can also guarantee the total traceability of the manufactured parts.

PACKAGING CONFEZIONAMENTO



PACKAGING

Multi-packs wrapping in shrink nylon.
Imballaggio in confezioni multiple in nylon termoretrato.

GALVANIZED FINITURA ZINCATA



FEATURES

Product especially suitable for maritime areas.
Prodotto particolarmente adatto alle zone marine.

STAINLESS STEEL FINITURA INOX



FEATURES

Made entirely of stainless steel.
Realizzato completamente in acciaio inox per i più esigenti.

ELECTROGAL- VANISED FINITURA ELETTROZINCATA



FEATURES

This product is electro-galvanized and painted after welding.
Prodotto elettrozincato e verniciato dopo la saldatura.

PRODOTTI IN ITALIA

L'impiego delle più avanzate tecnologie per la trasformazione della lamiera ci consente non soltanto di produrre in tempi rapidi e concorrenziali, ma anche e soprattutto di offrire prodotti certificati secondo le più restrittive normative di settore. Grazie all'alto livello di automazione dei nostri processi produttivi, inoltre, possiamo assicurare la totale rintracciabilità dei pezzi prodotti.

Certified products and processes are the best guarantee of quality we can offer you.

Prodotti e processi certificati sono la migliore garanzia di qualità che possiamo offrirvi.



We are serious about our work and to ensure a consistently reliable product, we have sought help from those who are experts in this subject. Notified bodies, recognized test laboratories and certifications guarantee the quality and reliability of our products.

Prendiamo sul serio il nostro lavoro e per garantire un prodotto sempre affidabile, ci siamo fatti aiutare da chi di questa materia è esperto. Enti notificati, laboratori prova e certificazioni riconosciute, garantiscono la qualità ed affidabilità dei nostri prodotti.



ADJUSTABLE REAR FOOT PIEDINI REGOLABILI



ADJUSTABLE

Adjustable rear foot in nylon with slot hollow for 6 mm allen key.
Piedino posteriore regolabile in nylon con cava per chiave a brugola 6 mm.

PRE-ASSEMBLED PREMONTATA



EASY

The product is made in electro-galvanized steel and is purchased pre-assembled.
Prodotto in acciaio elettrozincato e fornito pre-montato.

WALL FIXING KIT FISSAGGI A PARETE



WALL KIT

Fixing kit supplied with nylon anchor M12x80 and 8x80 galvanized screws.
Kit di fissaggio in dotazione con tasselli in nylon M12x80 e viti 8x80 zincate.

PERMANENT MARKING MARCATURA



WARRANTY

Products warranted and permanently marked with our name.
Progetti garantiti e marcati indelebilmente con il nostro nome.

WHY

Since 1990, we have been engaged in the industrial manufacture of brackets and accessories for air conditioning, at the same time managing to maintain the flexibility and care typical of artisan work. This, along with a careful before/after sales service, enables us to continue to design and construct brackets in order to, meeting the needs of the most demanding customers. We like to give shape to your requests by turning them into services. This can be seen by the customised packaging, made possible by our automated packaging line which, as well as enabling us to deliver orders in a very short time, guarantees complete traceability of the manufactured parts. Lastly, TÜV certification means that we can reassure customers in the choice of reliable products: all our articles, as required by the certification, are designed to withstand a load three to five times higher than that declared.

INSULATING WASHERS RONDELLE ISOLANTI



JUNCTION KIT

Kit of insulating washers complete with nuts and bolts.
Kit di rondelle isolanti complete di bulloneria.

PATENTED LEVELLING LIVELLA BREVETTATA



QUICK INSTALLATION

Levelling system for an easy and rapid installation.
Livella per una facile e rapida installazione.

MOUNTING INSTRUCTIONS MANUALE ISTRUZIONI



INSTRUCTIONS

In each box we provide mounting instructions.
In ogni confezione è presente un foglio di istruzioni per l'uso.

TRACEABILITY RINTRACCIABILITÀ



BOX

Maximum traceability thanks to the progressive production code.
Massima rintracciabilità grazie al codice di produzione progressivo.

PERCHÉ

Dal 1990 ci occupiamo della produzione industriale di mensole e accessori per il condizionamento riuscendo, al contempo, a mantenere la flessibilità e l'attenzione tipiche del lavoro artigianale. Questa accortezza, insieme a un accurato servizio pre e post vendita, ci permette di continuare a progettare e costruire mensole su ordinazione, rispondendo alle necessità dei clienti più esigenti. Ci piace dare forma alle Vostre richieste trasformandole in servizi. Lo dimostra la personalizzazione degli imballaggi, resa possibile dalla nostra linea di confezionamento automatizzato che, oltre a permetterci di consegnare gli ordini in tempi brevissimi, garantisce la totale rintracciabilità dei pezzi prodotti. La certificazione TÜV, infine, ci permette di assicurare il cliente nella scelta di prodotti affidabili: ogni nostro articolo, come richiesto dalla certificazione, è progettato per resistere a un carico da tre a cinque volte superiore rispetto a quello dichiarato.

We pay attention to
your needs and
always offer you
innovative products.

Facciamo attenzione alle tue esigenze e
ti offriamo prodotti sempre innovativi.

In an ever wider market, there is no lack of space for less common installations that require a suitable product. Our continuous dialogue with our customers allows us to develop products that are devoted to unusual installations.

In un mercato sempre più ampio, non manca lo spazio per le installazioni meno comuni, che richiedono un prodotto adatto. Il nostro continuo confronto con i nostri clienti, ci permette di sviluppare prodotti dedicati a installazioni poco frequenti.



ANTI-VIBRATION
FOOT
PIEDINO
ANTIVIBRANTE



FEATURES

Adjustable rear foot in nylon with slot hollow for 6 mm allen key.
Piedino posteriore regolabile in nylon con cava per chiave a brugola 6 mm.

PERMANENT
MARKING
MARCATURA



FEATURES

The product is made in electro-galvanized steel and is purchased pre-assembled.
Prodotto in acciaio elettrozincato e fornito pre-montato.

INSULATING
WASHERS
RONDELLE ISOLANTI

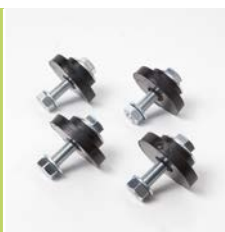

FEATURES

Fixing kit supplied with nylon anchor M12x80 and 8x80 galvanized screws.
Kit di fissaggio in dotazione con tasselli in nylon M12x80 e viti 8x80 zincate.

TRACEABILITY
RINTRACCIABILITÀ



FEATURES

Products warranted and permanently marked with our name.
Progetti garantiti e marcati indelebilmente con il nostro nome.

THE REAL STRENGTH OF RODIGAS LIES IN THE PEOPLE WHO HAVE CHOSEN TO WORK WITH US

Rodigas is made up of many different people who, every day, offer creativity, ingenuity and passion for the creation of new projects: Men and women who work together with enthusiasm to obtain the best from the union of their expertise.

OTHER TYPES OF
FLOOR SUPPORT
ALTRE TIPOLOGIE DI SUPPORTI
A PAVIMENTO



FEATURES

Kit of insulating washers complete with nuts and bolts.
Kit di rondelle isolanti complete di bulloneria.

LA VERA FORZA DI RODIGAS È NELLE PERSONE CHE HANNO SCELTO DI LAVORARE CON NOI

Rodigas è fatta di tante e diverse persone che, ogni giorno, offrono creatività, ingegno e passione per la realizzazione di nuovi progetti: uomini e donne che si confrontano con entusiasmo per ottenere il meglio dall'unione delle proprie esperienze.

We have made it
since 1996, it was the
first and still amazing.

La facciamo nello stesso modo dal 1996,
è stata la prima e ancora stupisce

The embedding box is the first embedded box with "pouch" studied specifically for air conditioning employment. Thanks to the patented solutions, it is the only box that doesn't need cross girders as reinforcement to avoid any deformation; the cover is in fact equipped with very strong small plates used for fixing of the template of the conditioner.

La prima scatola con marsupio studiata appositamente per il condizionamento. Grazie ai suoi brevetti, è l'unica scatola che non ha bisogno di traversini di rinforzo antideformazione, perchè il coperchio è dotato di placchette molto robuste da utilizzare nel fissaggio della dima del condizionatore. Il materiale di realizzazione è in grado di supportare qualsiasi sforzo dovuto alla messa in opera muraria ed il gocciolatoio esclude la necessità di sostituzione anche in caso di danneggiamento.



LEVELLING SYSTEM SISTEMA DI LIVELLAMENTO

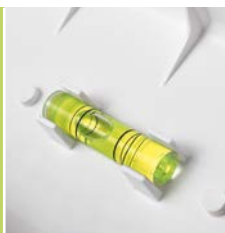

LEVEL

Optional levelling system.
Sistema di livellamento opzionale.

DISCHARGE ON TWO SIDES DISCHARGE ON TWO SIDES



DUBLE SIDE

Tub housed inside the box with inspectable hoses.
Vaschetta alloggiata all'interno della scatola con manicotti ispezionabili.

SUITABLE PREDRILLED HOLES PREFORATURE IDONEE



HOLES

Predrilled holes positioned to allow the universal use.
Preforature posizionate in modo da rendere l'uso universale.

OUTER LID COPERCHIO ESTERNO



OUTER LID

Construction site optional cover to protect the inside of the box during the wall plastering.
Coperchio da cantiere opzionale per proteggere l'interno della scatola durante l'intonacatura della parete.

MUNTIFUNCTIONAL COVER

The optional cover from outdoor CP300 is a unique body with the box and, for this reason, it makes unnecessary the application of an external systems of alignment (as required in other types of boxes); beside it protects the inside part of box during the building works. The box was introduced in the market on 1996, it had further implementations that allow a large diffusion and the constant success.

MULTIFUNCTIONAL COVER COPERCHIO MULTIFUNZIONE



FEATURES

Once protected the pipes by the cover during the wall plastering, separate the two ending parts to fix the indoor unit template.

Una volta utilizzato il coperchio per proteggere le tubazioni in fase di intonacatura della parete si separano le due estremità e si utilizzano per il fissaggio della dima dell'unità interna.

MULTIFUNCTIONAL COVER COPERCHIO MULTIFUNZIONE



PUMP SPACE ALLOGGIAMENTO POMPA SCARICO



DRAIN PUMP

By removing the drip tray, it is possible accomodate a condensate drain pump.

Rimuovendo il gocciolatoio è possibile alloggiare una pompa per lo scarico della condensa.

FIXING PLATE PALCCHETTE FISSAGGIO DIMA



PLATES

Plates applicable to the box for fixing the external air conditioning unit.

Placchette applicabili alla scatola per il fissaggio della dima dell'unità esterna di condizionamento.

COPERCHIO DA CANTIERE

Il coperchio da cantiere CP300 opzionale è un corpo unico con la scatola, che rende inutile l'applicazione di sistemi esterni di allineamento (di cui necessitano invece altri tipi di scatole) proteggendo anche l'interno scatola in fase di completamento delle opere murarie. Nel lungo utilizzo dal 1996, quando è stata immessa nel mercato, fino ad oggi, ha subito ulteriori implementazioni che ne determinano il continuo successo e larga diffusione.



SLID

SLIDING BRACKETS

> Sliding > Frontal hook > Crossbar

MENSOLE SCORREVOLI

> *Scorrevole* > *Aggancio frontale* > *Barra a muro*

SLIDING



ADJUSTABLE
REAR FOOT



WALL
FIXING KIT



INSULATING
WASHERS



LEVELLING
SYSTEM



Management
System
ISO 9001:2008
www.tuv.com
ID 0105070334



MATERIALS AND TREATMENT

Materials: electro-galvanised steel plate
Treatment: painting epoxy resins in polyester
Colour: Ral 9002
Joint: high resistant screw M6x70 8.8
Adjustment: 2 adjustable gummy polypropilene feet (patented)
Equipped with: level to adjust the wall bar, wall fixing kit, insulating washers



LOAD CAPACITY

Domestic use: 140 Kg
Contract use: 84 Kg
Load testing weight: 420 Kg



BOX

Pack: carton box
Pieces: 1
Pack dimensions: 85x90x820 mm
Case weight: 3.5 kg



PALLET

Pallet dimensions: 120x80x100 cm
Pieces per pallet: 117
Pallet total weight: 420 kg



DIMENSIONS AND LOADING CAPACITY

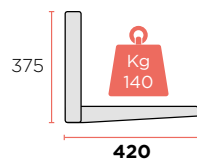
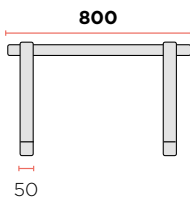

BRACKET DRILLING DIAGRAM

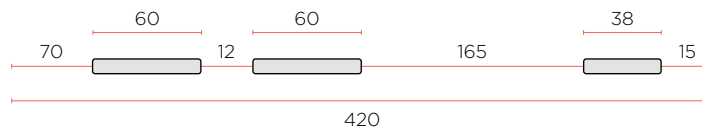

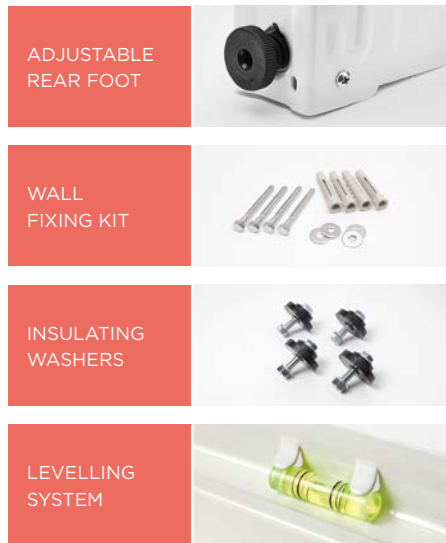

MATERIALS AND TREATMENT

Materials: electro-galvanised steel plate
Treatment: painting epoxy resins in polyester
Colour: Ral 9002
Joint: high resistant screw M6x70 8.8
Adjustment: 2 adjustable gummy polypropilene feet (patented)
Equipped with: level to adjust the wall bar, wall fixing kit, insulating washers

LOAD CAPACITY

Domestic use: 100 Kg
Load testing weight: 300 Kg

BOX

Pack: carton box
Pieces: 1
Pack dimensions: 85x90x610 mm
Case weight: 3,5 kg

PALLET

Pallet dimensions: 120x80x100 cm
Pieces per pallet: 170
Pallet total weight: 600 kg



DIMENSIONS AND LOADING CAPACITY

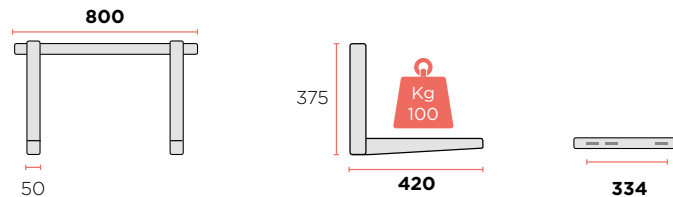

BRACKET DRILLING DIAGRAM

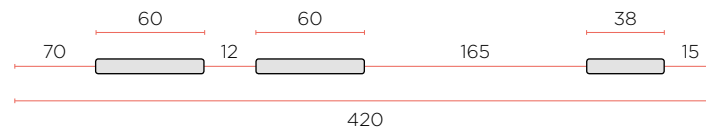

SMALL PACKAGING



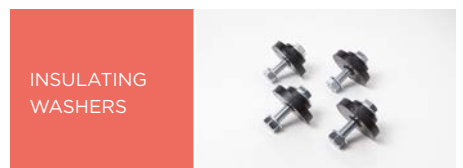
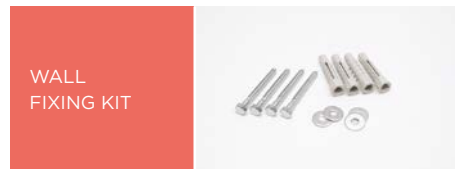

DIMENSIONS AND LOADING CAPACITY

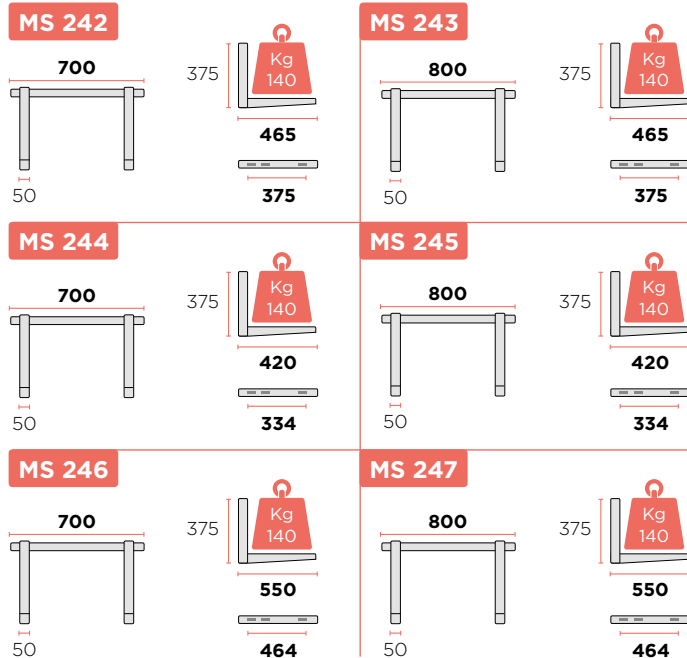

BRACKET DRILLING DIAGRAM

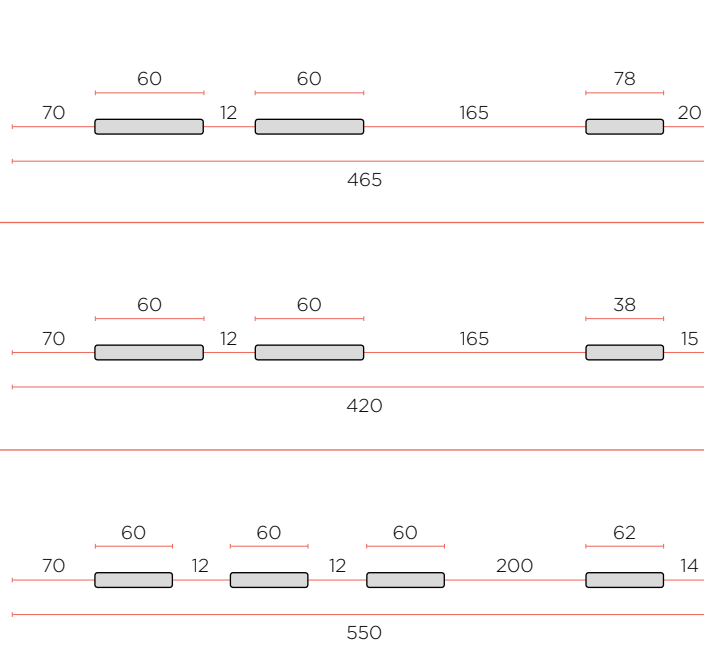

MATERIALS AND TREATMENT

Material: electro-galvanised steel plate
Treatment: epoxy resins in polyester for outdoor
Colour: Ral 9002
Joint: high resistant screw M6x70 8.8
Adjustment: 2 adjustable gummy polypropilene feet (patented)

LOAD CAPACITY

Domestic use: 140 Kg
Contract use: 84 Kg
Load testing weight: 420 Kg

BOX

Pack: carton box
Pieces: 1
Pack dimensions: 85x90x820 mm
Case weight: 4.2 kg

PALLET

Pallet dimensions: 120x80x100 cm
Pieces per pallet: 117
Pallet total weight: 500 kg

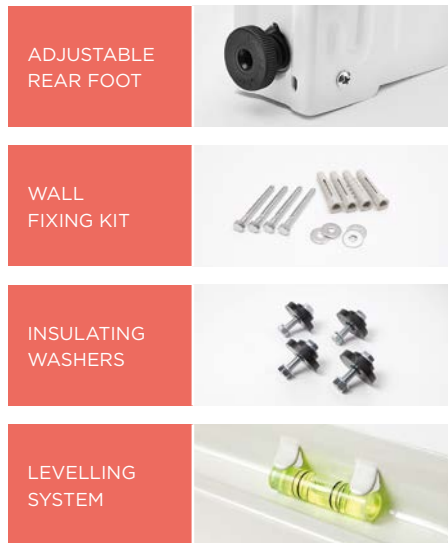

MATERIALS AND TREATMENT

Material: electro-galvanised steel plate
Treatment: epoxy resins in polyester for outdoor
Colour: Ral 9002
Joint: high resistant screw M6x70 8.8
Adjustment: 2 adjustable polypropilene feet
Equipped with: level to adjust the wall bar

LOAD CAPACITY

Domestic use: 140 Kg
Contract use: 84 Kg
Load testing weight: 420 Kg

BOX

Pack: carton box
Pieces: 1
Pack dimensions: 85x90x820 mm
Case weight: 4.2 kg

PALLET

Pallet dimensions: 120x80x100 cm
Pieces per pallet: 117
Pallet total weight: 500 kg

DIMENSIONS AND LOADING CAPACITY

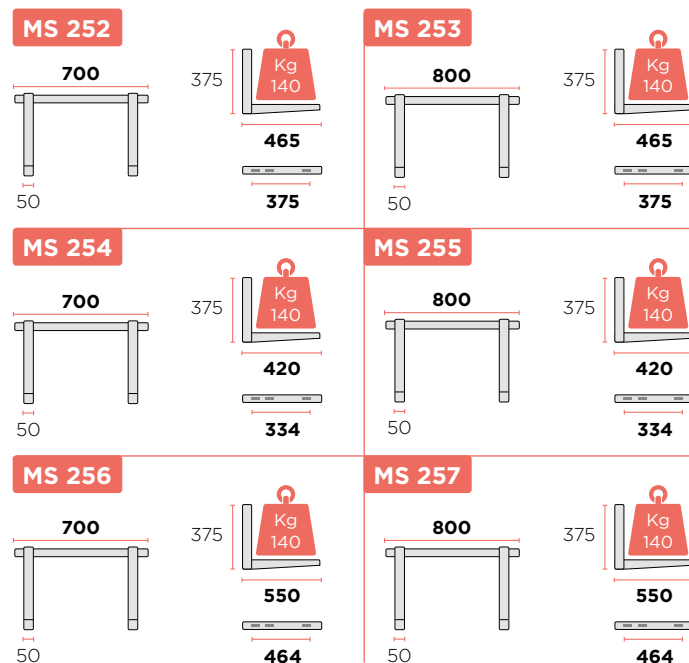

BRACKET DRILLING DIAGRAM

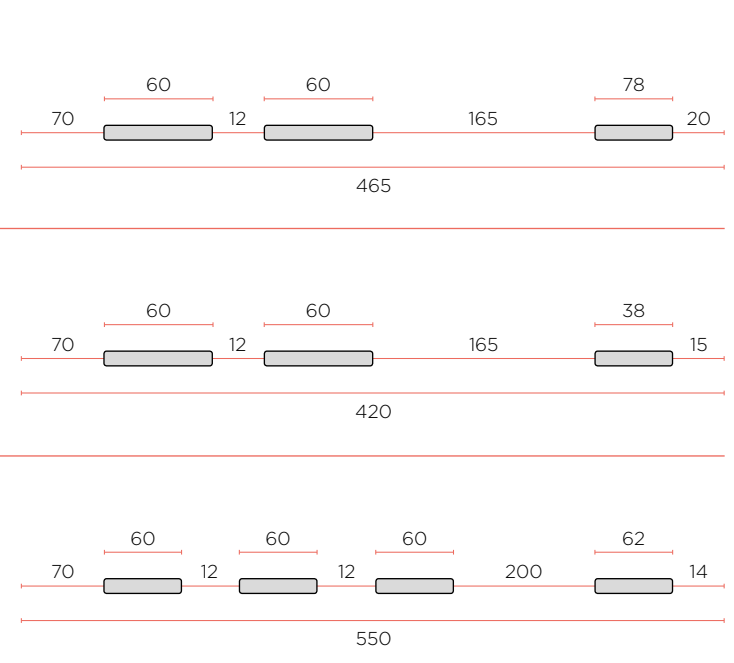



MAGNELIS®

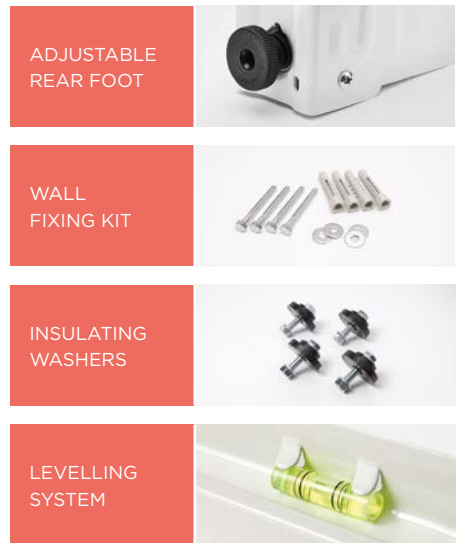

Management System
ISO 9001:2008
www.rodigas.com
ID: 9105073334



MATERIALS AND TREATMENT

Materials: magnelis®

Treatment: painting epoxy resins in polyester

Colour: Natural

Joint: high resistant screw M6x70 8.8

Adjustment: 2 adjustable gummy polypropilene feet (patented)

Equipped with: level to adjust the wall bar, wall fixing kit, insulating washers



LOAD CAPACITY

Domestic use: 100 Kg



BOX

Pack: carton box

Pieces: 1

Pack dimensions: 85x90x820 mm

Case weight: 3.5 kg



PALLET

Pallet dimensions: 120x80x100 cm

Pieces per pallet: 117

Pallet total weight: 420 kg



ABOUT MAGNELIS®

Our new line of technological product made in Magnelis® prevent corrosion more then standard product and is it recomendaded even in the most hostile environments.

Magnelis® is an exceptional metallic coating which provides a breakthrough in corrosion protection. For more info, please contact out technical team.



INFORMAZIONI TECNICHE

La nostra nuova linea di prodotti tecnologici realizzati in Magnelis® impedisce la corrosione più del prodotto standard e viene consigliata anche negli ambienti più corrosivi.

Magnelis® è un rivestimento metallico eccezionale che fornisce una penetrazione nella protezione contro la corrosione. Per ulteriori informazioni, contattare il team tecnico.



DIMENSIONS AND LOADING CAPACITY

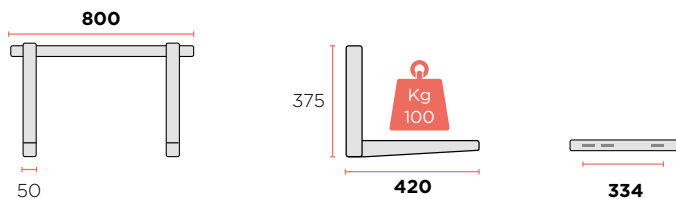

BRACKET DRILLING DIAGRAM

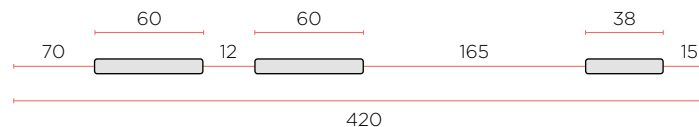

INOX WALL
FIXING KIT



INOX
INSULATING
WASHERS



LEVELLING
SYSTEM



Management
System
ISO 9001:2008
www.rodigas.com
ID 9105073334



MATERIALS AND TREATMENT

Material: AISI 304 stainless steel plate
Treatment: epoxy resins in polyester on request
Colour: Natural/Ral 9002
Joint: high resistant screw M6x70 8.8
Adjustment: 2 adjustable gummy polypropylene feet



BOX

Pack: carton box
Pieces: 1
Pack dimensions: 820x85x90 mm
Case weight: 4.2 kg



PALLET

Pallet dimensions: 120x80x100 cm
Pieces per pallet: 117
Pallet total weight: 500 kg

INOX



DIMENSIONS AND LOADING CAPACITY

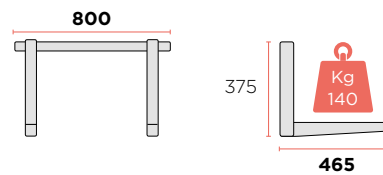

BRACKET DRILLING DIAGRAM

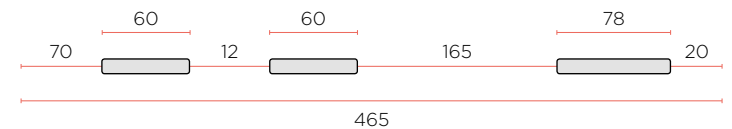



MATERIALS AND TREATMENT

Material: pickled steel
Frist treatment: electro cathoporesis
Second treatment: epoxy resins in polyester for outdoor
Colour: Ral 9002

BOX

MS 744 Pack: carton box Pieces: 1 Pack dimensions: 595x80x85 mm Case weight: 3.4 kg	MS 742 Pack: carton box Pieces: 1 Pack dimensions: 595x80x85 mm Case weight: 3.4 kg
--	--

MS 746 Pack: carton box Pieces: 1 Pack dimensions: 595x80x85 mm Case weight: 3.8 kg	MS 781 Pack: carton box Pieces: 1 Pack dimensions: 595x80x85 mm
--	---

DIMENSIONS AND LOADING CAPACITY

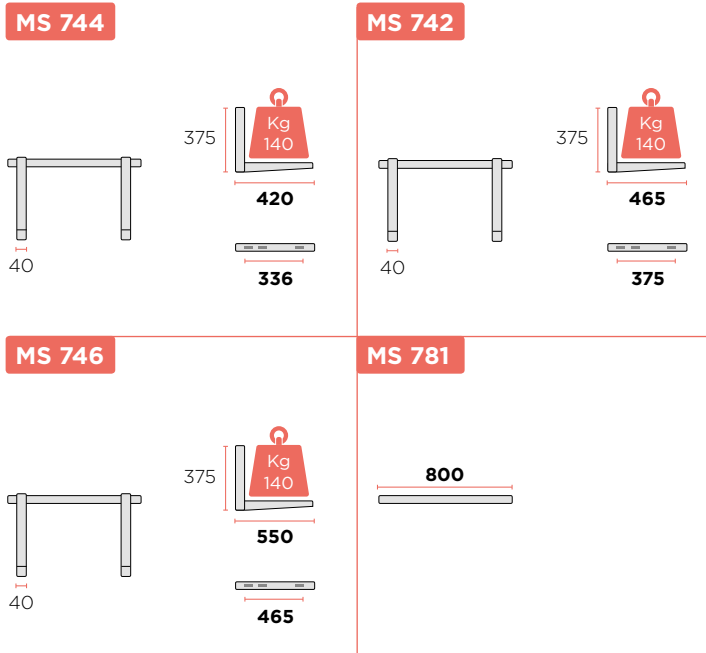

BRACKET DRILLING DIAGRAM

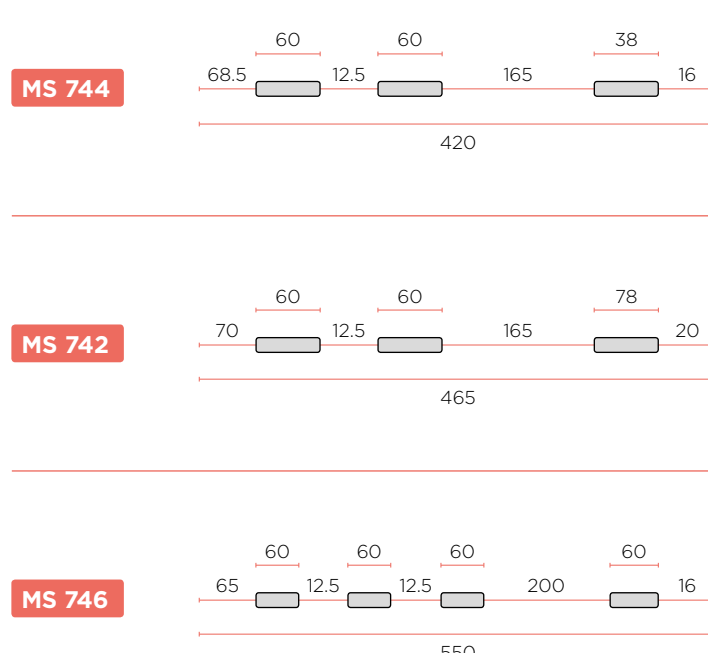

PALLET

MS 744 Pallet dimensions: 120x80x100 cm Couples per pallet: 170 Pallet total weight: 450 kg	MS 742 Pallet dimensions: 120x80x100 cm Couples per pallet: 170 Pallet total weight: 620 kg
MS 746 Pallet dimensions: 120x80x100 cm Couples per pallet: 170 Pallet total weight: 690 kg	

INOX WALL
FIXING KIT



INOX
INSULATING
WASHERS



LEVELLING
SYSTEM



Management
System
ISO 9001:2008
www.rodigas.com
ID: 8105073524



MATERIALS AND TREATMENT

Material: aluminium alloy
Treatment: epoxy resins in polyester on request
Colour: Natural/Ral 9002
Joint: high resistant screw M6x70 8.8
Adjustment: 2 adjustable gummy polypropylene feet



BOX

Pack: carton box
Pieces: 1
Pack dimensions: 820x85x90 mm
Case weight: 4.2 kg



PALLET

Pallet dimensions: 120x80x100 cm
Pieces per pallet: 117
Pallet total weight: 500 kg

ALLUMINIUM
ALLOY



DIMENSIONS AND LOADING CAPACITY

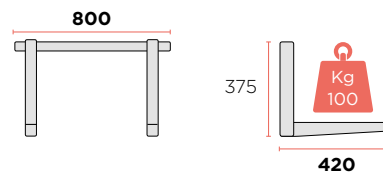

BRACKET DRILLING DIAGRAM

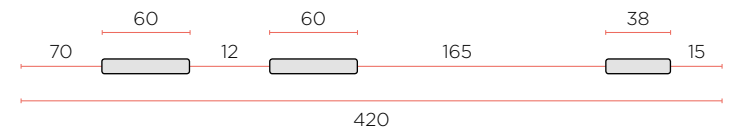

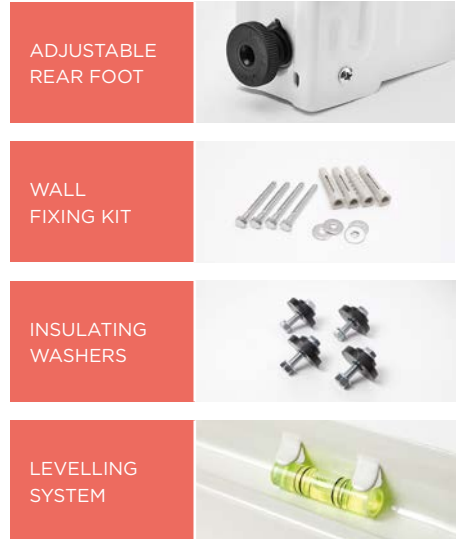

DIMENSIONS AND LOADING CAPACITY

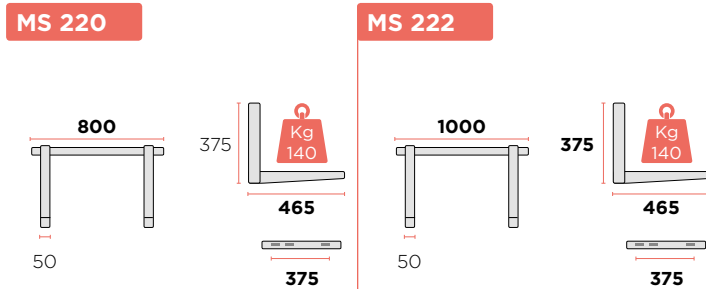

BRACKET DRILLING DIAGRAM

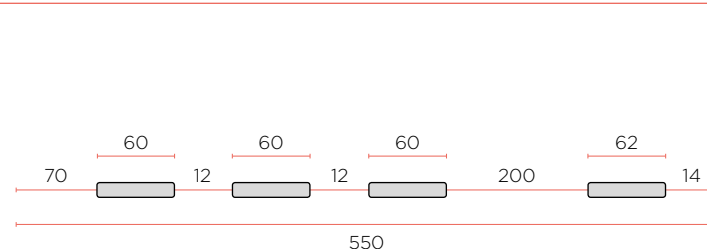
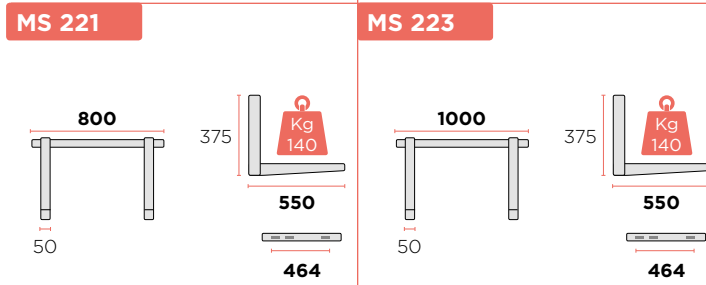
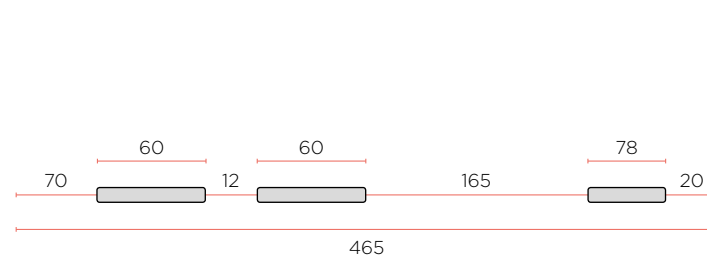

MATERIALS AND TREATMENT

Material: electro-galvanised steel plate
Treatment: epoxy resins in polyester for outdoor
Colour: Ral 9002
Joint: high resistant screw M6x70 8.8
Adjustment: 2 adjustable gummy polypropilene feet (patented)

LOAD CAPACITY

Domestic use: 140 Kg
Contract use: 84 Kg
Load testing weight: 420 Kg

BOX

Pack: carton box
Pieces: 1
Pack dimensions: 820x85x90 mm
Case weight: 4.84 kg

PALLET

Pallet dimensions: 120x80x100 cm
Pieces per pallet: 117
Pallet total weight: 540 kg

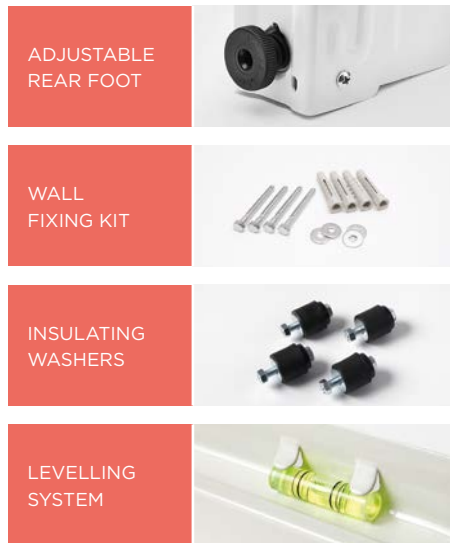

MATERIALS AND TREATMENT

Materials: electro-galvanised steel plate
Horizontal rod material: aluminium alloy
Treatment: epoxy resins in polyester for outdoor
Colour: Ral 9002
Joint: high resistant screw M6x70 8.8
Adjustment: 2 adjustable gummy polypropilene feet (patented)

BOX

Pack: carton box
Pieces: 1
Pack dimensions: 120x20x13 mm

PALLET

Pallet dimensions: 120x120x140 cm
Pieces per pallet: 40

DIMENSIONS AND LOADING CAPACITY

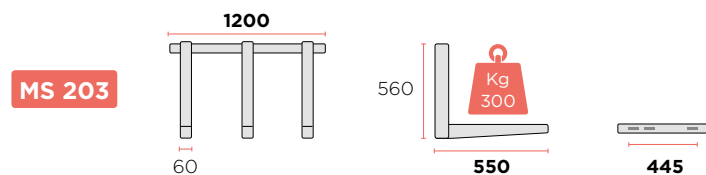
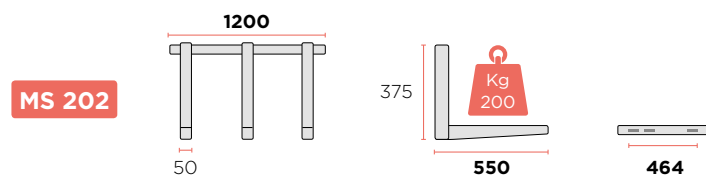
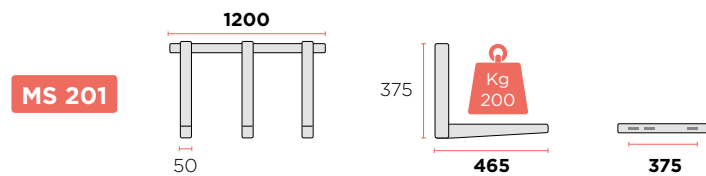

BRACKET DRILLING DIAGRAM

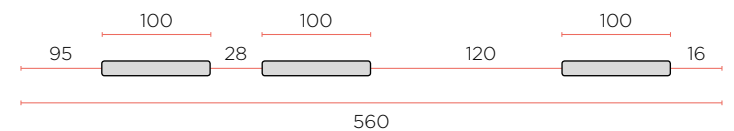
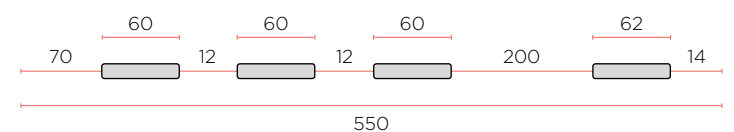
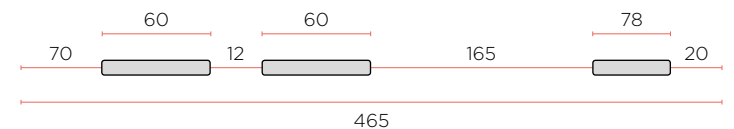

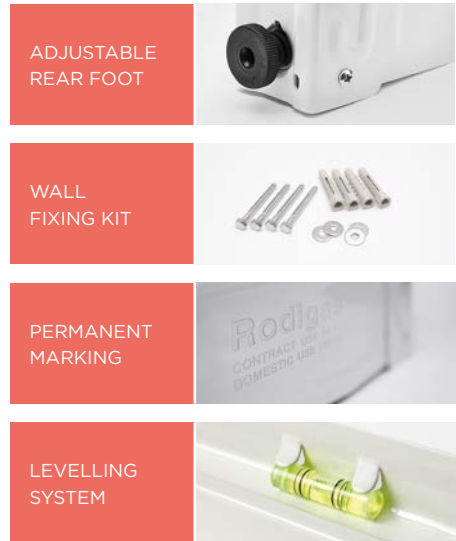

MATERIALS AND TREATMENT

Material: electro-galvanised steel plate
Horizontal rod material: aluminium alloy
Treatment: epoxy resins in polyester for outdoor
Colour: Ral 9002
Adjustment: 2 adjustable gummy polypropilene feet (patented)

DIMENSIONS AND LOADING CAPACITY

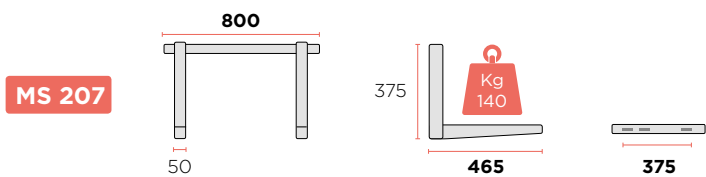

BRACKET DRILLING DIAGRAM

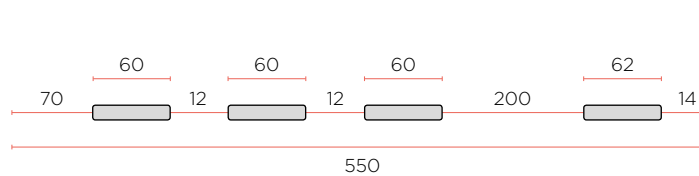
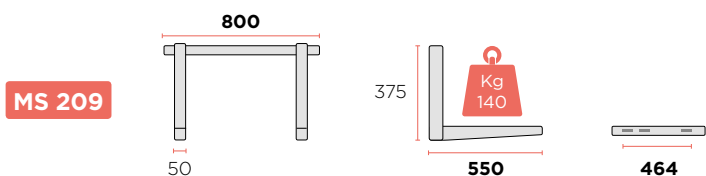
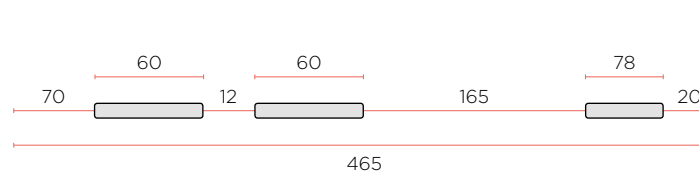

LOAD CAPACITY

Domestic use: 140 Kg
Contract use: 84 Kg
Load testing weight: 420 Kg

PALLET

MS 207 - 209
Pallet dimensions: 120x80x100 cm
Pieces per pallet: 117
Pallet total weight: 600 kg

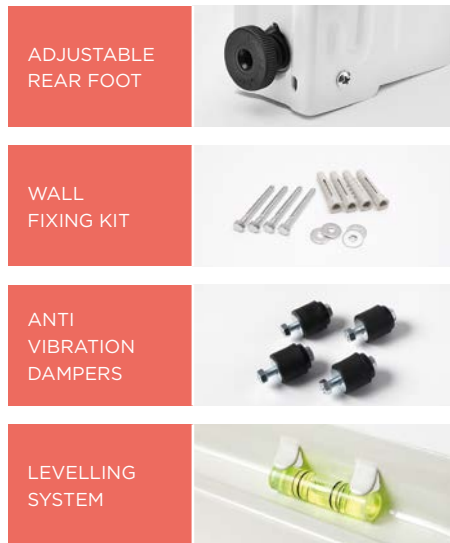

MATERIALS AND TREATMENT

Shelf material: electro-galvanised steel plate
Horizontal rod material: aluminium alloy
Treatment: epoxy resins in polyester for outdoor
Colour: Ral 9002
Joint: high resistant screw M6x70 8.8
Adjustment: 2 adjustable gummy polypropilene feet (patented)

BOX

Pack: carton box
Pieces: 1
Pack dimensions: 85x90x1060 mm
Case weight: 5 kg

PALLET

MS 208 - MS 219
Pallet dimensions: 106x106x100 cm
Pieces per pallet: 108
Pallet total weight: 550 kg



DIMENSIONS AND LOADING CAPACITY

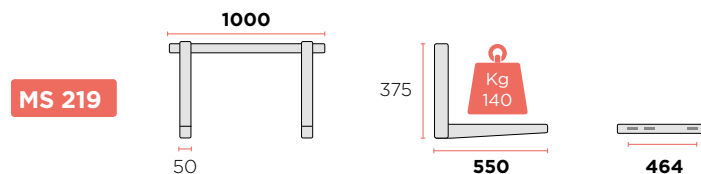
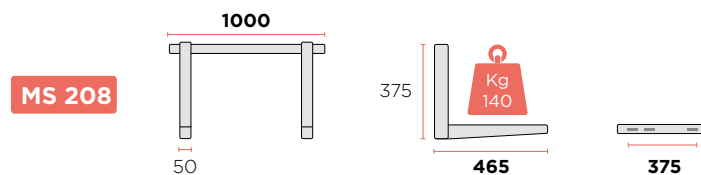

BRACKET DRILLING DIAGRAM

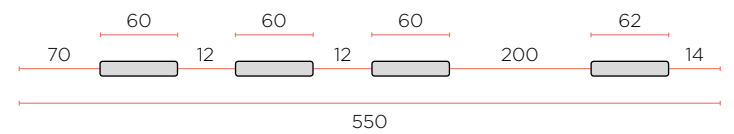
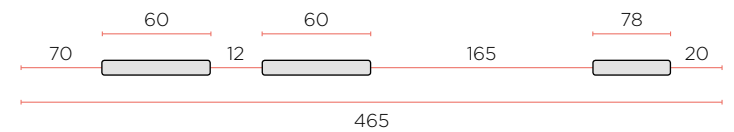

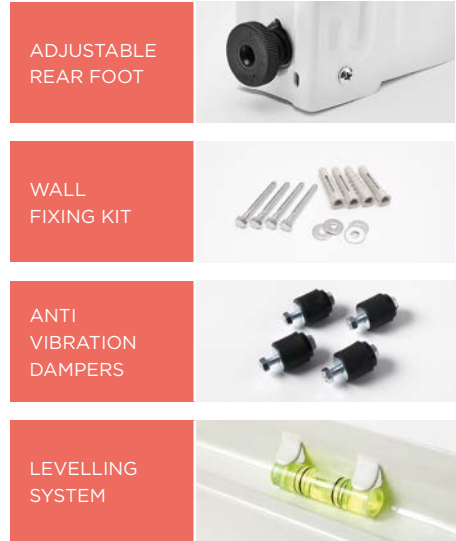

Management System
ISO 9001:2008
www.tuv.com
ID 9105073334



MATERIALS AND TREATMENT

Horizontal rod material: aluminium alloy
Material: electro-galvanised steel plate
Treatment: epoxy resins in polyester for outdoor
Colour: Ral 9002
Joint: high resistant screw M8x80 8.8
Adjustment: 4 adjustable gummy polypropylene feet (patented)



DIMENSIONS AND LOADING CAPACITY

MS 213

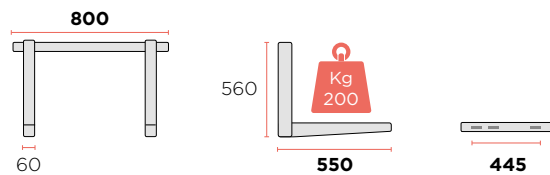

BRACKET DRILLING DIAGRAM

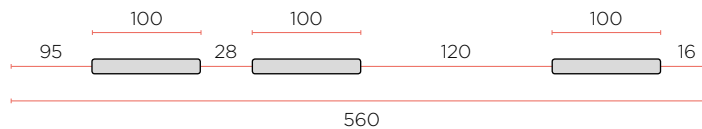

MS 214

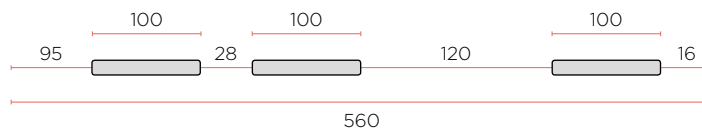
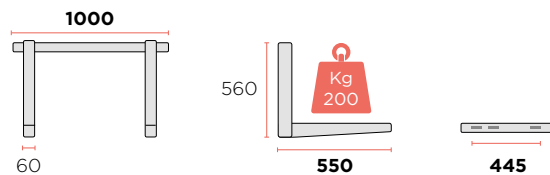

BOX

Pack: carton box
Pieces: 1
Pack dimensions: 1000x90x100 mm
Case weight: 7.5 kg



PALLET

Pallet dimensions: 120x120x100 cm
Pieces per pallet: 108
Pallet total weight: 810 kg

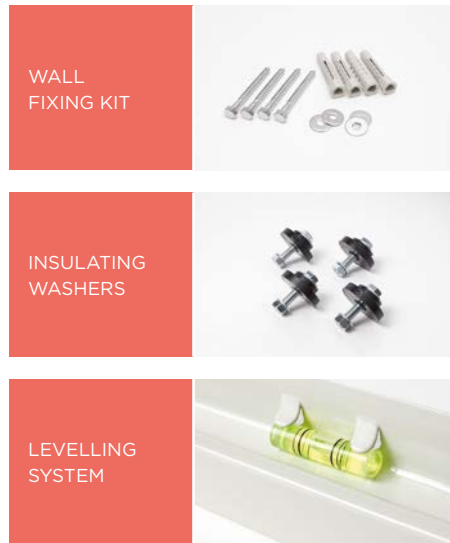

MATERIALS AND TREATMENT

Shelf material: electro-galvanised steel plate
Horizontal rod material: aluminium alloy
Treatment: epoxy resins in polyester for outdoor
Colour: Ral 9002

BOX

Pack: carton box
Pieces: 1
Pack dimensions: 970x85x90 mm
Case weight: 3.5 kg

PALLET

Pallet dimensions: 120x80x100 cm
Pieces per pallet: 117
Pallet total weight: 585 kg

DIMENSIONS AND LOADING CAPACITY

MS 205/A

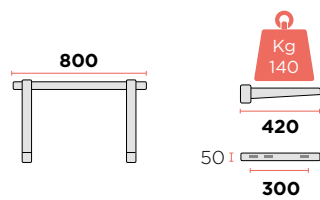

MS 205/B

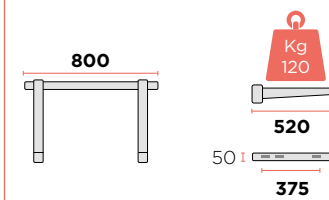

MS 206/A

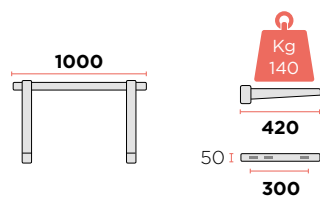

MS 206/B

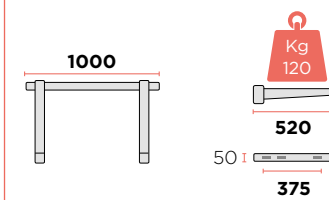

BRACKET DRILLING DIAGRAM

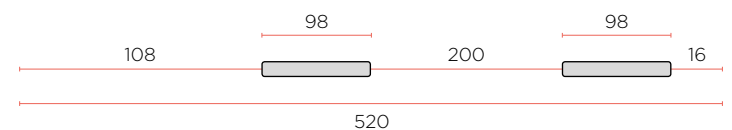
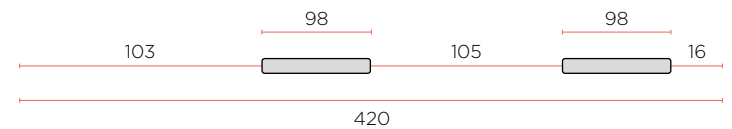



F

O

L

L

FOLDING BRACKETS
MENSOLE PIEGHEVOLI

DINING

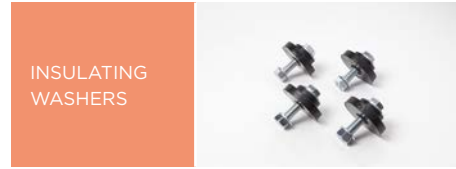

Management System
ISO 9001:2008
www.tuv.com
ID 919573334



MATERIALS AND TREATMENT

Material: electro-galvanised steel
Treatment: epoxy resins in polyester for outdoor
Colour: Ral 9002
Joint: high resistant screw M6x70 8.8



LOAD CAPACITY

Domestic use: 140 Kg
Contract use: 84 Kg
Load testing weight: 420 Kg



BOX

Pack: carton box
Pieces: 1
Pack dimensions: 110x70x490 mm
Case weight: 2.44 kg



PALLET

Pallet dimensions: 120x80x100 cm
Pieces per pallet: 170
Pallet total weight: 415 kg



DIMENSIONS AND LOADING CAPACITY

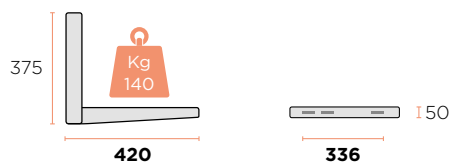

BRACKET DRILLING DIAGRAM

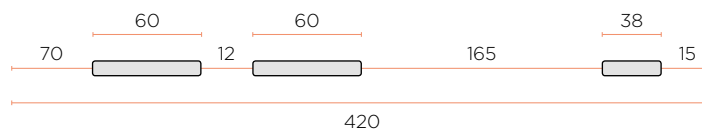

WALL
FIXING KIT



INSULATING
WASHERS



PRE
ASSEMBLED



Management
System
ISO 9001:2008



www.tuv.com
ID 9106073334



MATERIALS AND TREATMENT

Material: electro-galvanised steel

Treatment: epoxy resins in polyester for outdoor

Colour: Ral 9002

Joint: high resistant screw M6x70 8.8



LOAD CAPACITY

Domestic use: 140 Kg

Contract use: 84 Kg

Load testing weight: 420 Kg



BOX

Pack: carton box

Pieces: 1

Pack dimensions: 110x70x490 mm

Case weight: 2.44 kg



PALLET

Pallet dimensions: 120x80x100 cm

Pieces per pallet: 170

Pallet total weight: 415 kg



DIMENSIONS AND LOADING CAPACITY

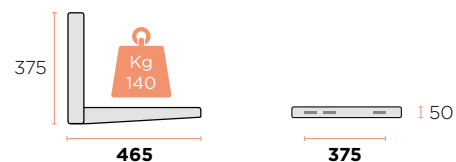

BRACKET DRILLING DIAGRAM

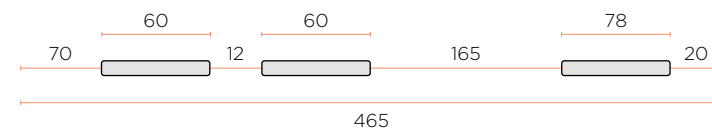

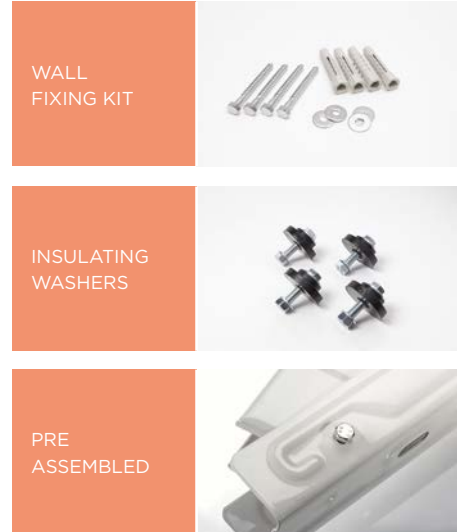

MATERIALS AND TREATMENT

Material: electro-galvanised steel
Treatment: epoxy resins in polyester for outdoor
Colour: Ral 9002
Joint: high resistant screw M6x70 8.8

LOAD CAPACITY

Domestic use: 140 Kg
Contract use: 84 Kg
Load testing weight: 420 Kg

BOX

Pack: carton box
Pieces: 1
Pack dimensions: 110x70x490 mm
Case weight: 3.8 kg

PALLET

Pallet dimensions: 120x80x100 cm
Pieces per pallet: 170
Pallet total weight: 650 kg

DIMENSIONS AND LOADING CAPACITY

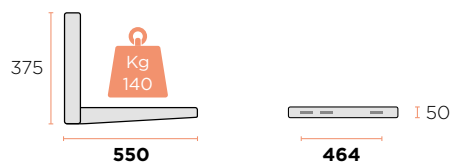

BRACKET DRILLING DIAGRAM

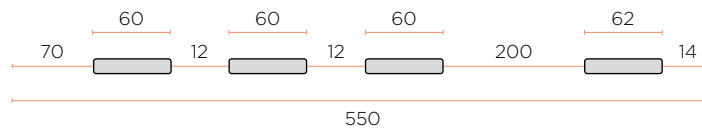

WALL
FIXING KIT



INSULATING
WASHERS



PERMANENT
MARKING



Management
System
ISO 9001:2008
www.rodigas.com
ID 919673334



MATERIALS AND TREATMENT

Material: electro-galvanised steel

Treatment: epoxy resins in polyester for outdoor

Colour: Ral 9002

Joint: high resistant screw M8x80 8.8



LOAD CAPACITY

Domestic use: 200 Kg

Load testing weight: 400 Kg



BOX

Pack: carton box

Pieces: 1

Pack dimensions: 85x90x820 mm

Case weight: 5.8 kg



PALLET

Pallet dimensions: 120x80x100 cm

Pieces per pallet: 117

Pallet total weight: 690 kg



DIMENSIONS AND LOADING CAPACITY

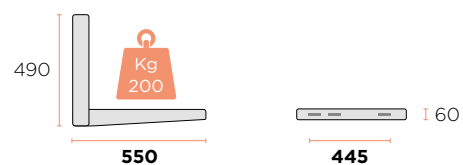

BRACKET DRILLING DIAGRAM

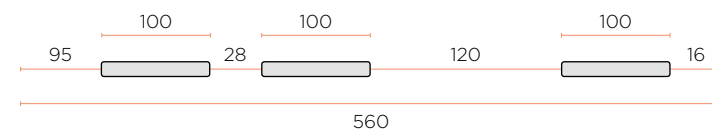



MAGNELIS®



ABOUT MAGNELIS®

Our new line of technological product made in Magnelis® prevent corrosion more than standard product and is it recommended even in the most hostile environments.

Magnelis® is an exceptional metallic coating which provides a breakthrough in corrosion protection. For more info, please contact our technical team.



INFORMAZIONI TECNICHE

La nostra nuova linea di prodotti tecnologici realizzati in Magnelis® impedisce la corrosione più del prodotto standard e viene consigliata anche negli ambienti più corrosivi.

Magnelis® è un rivestimento metallico eccezionale che fornisce una penetrazione nella protezione contro la corrosione. Per ulteriori informazioni, contattare il team tecnico.



DIMENSIONS AND LOADING CAPACITY

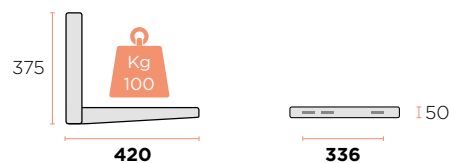

BRACKET DRILLING DIAGRAM

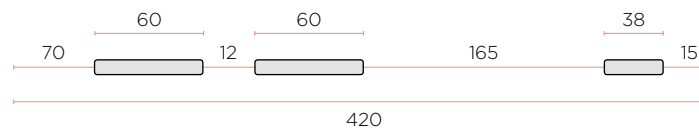

WALL
FIXING KIT



INSULATING
WASHERS



PERMANENT
MARKING



Management
System
ISO 9001:2008
www.tuv.com
ID 9199572334



MATERIALS AND TREATMENT

Material: magnelis®
Treatment: epoxy resins in polyester for outdoor
Colour: Natural
Joint: high resistant screw M6x70 8.8



LOAD CAPACITY

Standard use: 100 Kg



BOX

Pack: carton box
Pieces: 1
Pack dimensions: 110x70x490 mm
Case weight: 2.44 kg



PALLET

Pallet dimensions: 120x80x100 cm
Pieces per pallet: 170
Pallet total weight: 415 kg

WALL
FIXING KIT



INSULATING
WASHERS



ALLUMINIUM
ALLOY



Management
System
ISO 9001:2008
www.rodigas.com
ID 9105973334



MATERIALS AND TREATMENT

Material: aluminium alloy

Treatment: epoxy resins in polyester for outdoor

Colour: Ral 9002

Joint: high resistant screw M6x70 8.8



LOAD CAPACITY

Standard use: 140 Kg



BOX

Pack: carton box

Pieces: 1

Pack dimensions: 85x90x610 mm

Case weight: 1.7 kg



PALLET

Pallet dimensions: 120x80x100 cm

Pieces per pallet: 117

Pallet total weight: 300 kg



DIMENSIONS AND LOADING CAPACITY

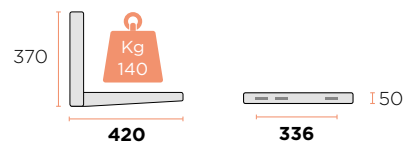

BRACKET DRILLING DIAGRAM

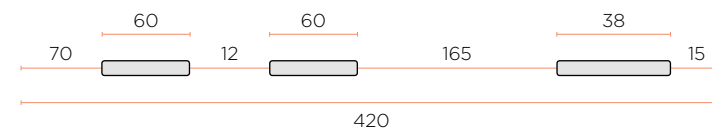

A close-up photograph of a white metal structure, possibly a wheel or a frame, featuring several oval-shaped holes. The image is overlaid with the word "WHEEL" in a large, white, sans-serif font. The background is a warm, orange-brown color.

WHEEL

WELDED BRACKETS

> Sliding > Frontal hook > Crossbar

MENSOLE SALDATE

> *Scorrevole* > *Aggancio frontale* > *Barra a muro*

WELDED



MATERIALS AND TREATMENT

Material: pickled steel
Treatment: hot galvanizing
Colour: as treatment

BOX

MS 104 101 Pack: thermo retractable pack Couples: 20 Single piece weight: 1.00 kg Case weight: 40 kg	MS 105 102 Pack: thermo retractable pack Couples: 20 Single piece weight: 1.20 kg Case weight: 45 kg
---	---

MS 106 110 Pack: thermo retractable pack Couples: 12 Single piece weight: 1.32 kg Case weight: 32 kg	MS 116 107 Pack: thermo retractable pack Couples: 5 Single piece weight: 2.60 kg Case weight: 26 kg
---	--

DIMENSIONS AND LOADING CAPACITY

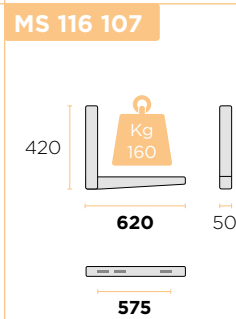
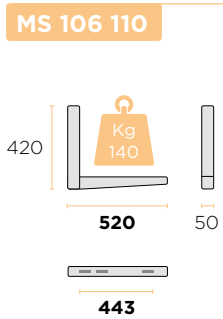
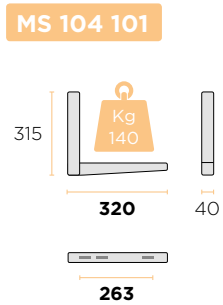

BRACKET DRILLING DIAGRAM

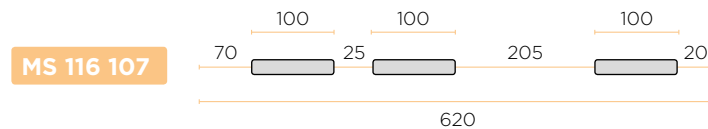
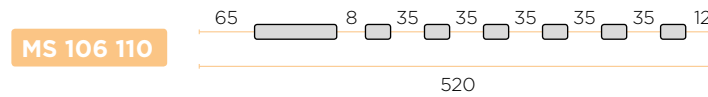
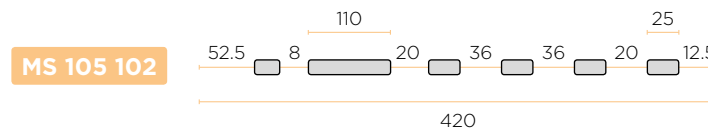
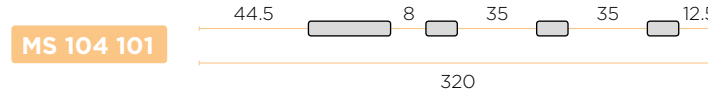

PALLET

MS 104 101 Pallet dimensions: 120x80x100 cm Couples per pallet: 200 Pallet total weight: 430 kg	MS 105 102 Pallet dimensions: 120x80x100 cm Couples per pallet: 200 Pallet total weight: 480 kg
--	--

MS 106 110 Pallet dimensions: 120x80x100 cm Couples per pallet: 168 Pallet total weight: 350 kg	MS 116 107 Pallet dimensions: 120x80x100 cm Couples per pallet: 90 Pallet total weight: 450 kg
--	---



MATERIALS AND TREATMENT

Material: pickled steel
Treatment: epoxy resins in polyester for outdoor
Colour: Ral 9002

BOX

<p>MS 104 Pack: thermo retractable pack Couples: 20 Single piece weight: 1.00 kg Case weight: 40 kg</p>	<p>MS 105 Pack: thermo retractable pack Couples: 20 Single piece weight: 1.20 kg Case weight: 45 kg</p>
--	--

<p>MS 106 Pack: thermo retractable pack Couples: 12 Single piece weight: 1.32 kg Case weight: 32 kg</p>	<p>MS 116 Pack: thermo retractable pack Couples: 5 Single piece weight: 2.60 kg Case weight: 26 kg</p>
--	---

PALLET

<p>MS 104 Pallet dimensions: 120x80x100 cm Couples per pallet: 200 Pallet total weight: 430 kg</p>	<p>MS 105 Pallet dimensions: 120x80x100 cm Couples per pallet: 200 Pallet total weight: 480 kg</p>
<p>MS 106 Pallet dimensions: 120x80x100 cm Couples per pallet: 168 Pallet total weight: 350 kg</p>	<p>MS 116 Pallet dimensions: 120x80x100 cm Couples per pallet: 90 Pallet total weight: 450 kg</p>



DIMENSIONS AND LOADING CAPACITY

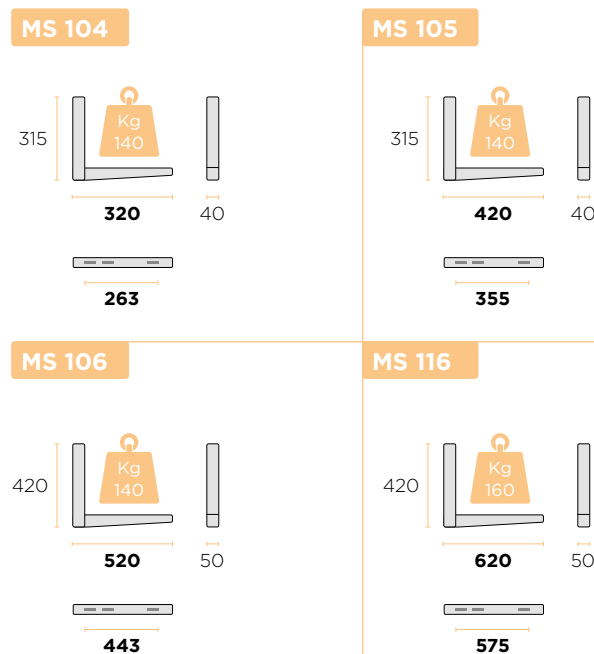

BRACKET DRILLING DIAGRAM

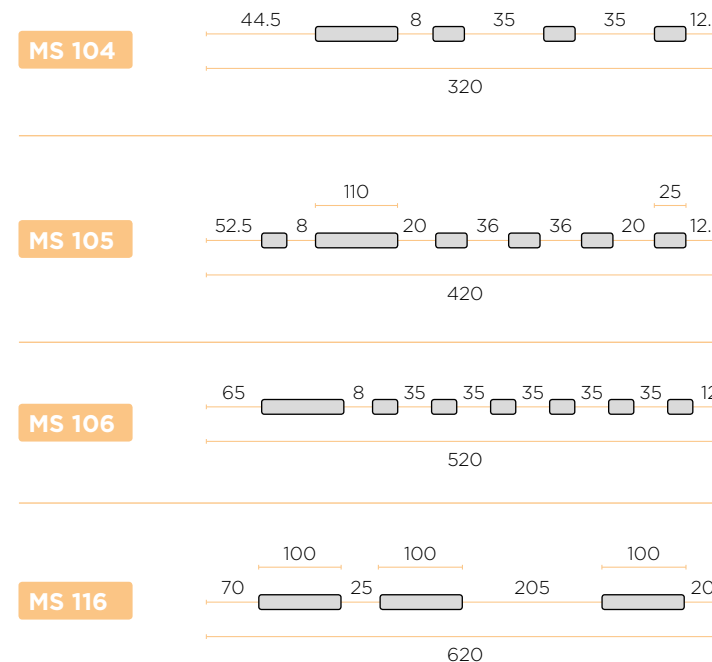



MATERIALS AND TREATMENT

Material: pickled steel
Frist treatment: electro galvanized
Second treatment: epoxy resins in polyester for outdoor
Colour: Ral 9002

BOX

MS 104 301
Pack: thermo retractable pack
Couples: 20
Single piece weight: 1.00 kg
Case weight: 40 kg

MS 105 302
Pack: thermo retractable pack
Couples: 20
Single piece weight: 1.20 kg
Case weight: 45 kg

MS 106 303
Pack: thermo retractable pack
Couples: 12
Single piece weight: 1.32 kg
Case weight: 32 kg

MS 116 304
Pack: thermo retractable pack
Couples: 5
Single piece weight: 2.60 kg
Case weight: 26 kg

DIMENSIONS AND LOADING CAPACITY

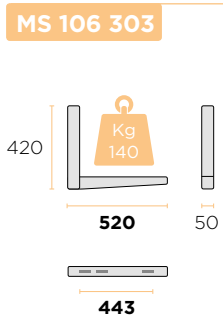
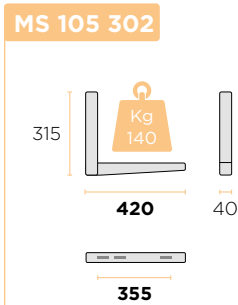
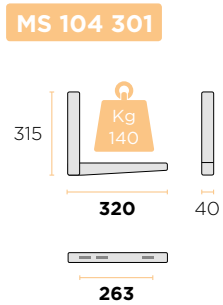

BRACKET DRILLING DIAGRAM

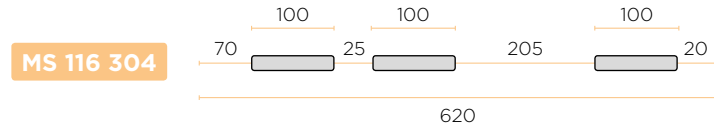
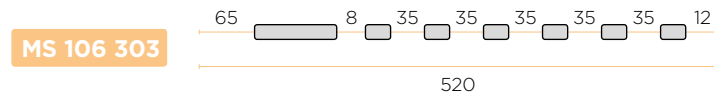
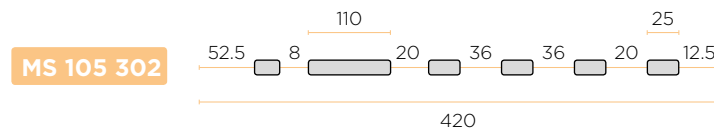
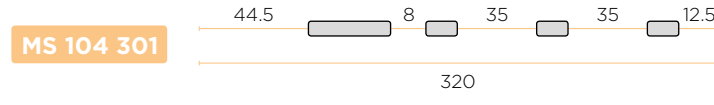

PALLET

MS 104 301
Pallet dimensions: 120x80x100 cm
Couples per pallet: 200
Pallet total weight: 430 kg

MS 105 302
Pallet dimensions: 120x80x100 cm
Couples per pallet: 200
Pallet total weight: 480 kg

MS 106 303
Pallet dimensions: 120x80x100 cm
Couples per pallet: 168
Pallet total weight: 350 kg

MS 116 304
Pallet dimensions: 120x80x100 cm
Couples per pallet: 90
Pallet total weight: 450 kg



MATERIALS AND TREATMENT

Material: pickled steel
Treatment: epoxy resins in polyester for outdoor
Colour: Ral 9002

LOAD CAPACITY

Domestic use: 140 Kg
Contract use: 84 Kg
Load testing weight: 420 Kg

BOX

MS 113	MS 123
Pack: thermo-retractable pack	Pack: thermo-retractable pack
Couples: 10	Couples: 12
Case height: 190 mm	Case height: 120 mm
Single piece weight: 1.12 kg	Single piece weight: 2.6 kg
Case weight: 22 kg	Case weight: 52 kg

PALLET

MS 113	MS 123
Pallet dimensions: 120x80x100 cm	Pallet dimensions: 120x80x100 cm
Couples per pallet: 200	Couples per pallet: 120
Pallet total weight: 480 kg	Pallet total weight: 470 kg



DIMENSIONS AND LOADING CAPACITY

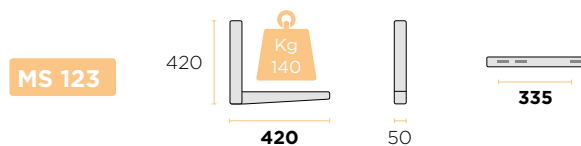
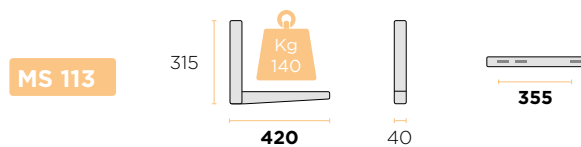

BRACKET DRILLING DIAGRAM

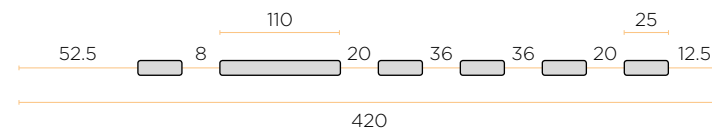
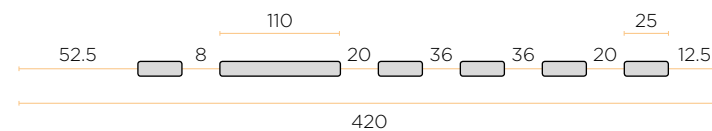



MATERIALS AND TREATMENT

Material: pickled steel
Frist treatment: electro galvanized
Second treatment: epoxy resins in polyester for outdoor
Colour: Ral 9002

BOX

MS 401 Pack: thermo-retractable pack Couples: 5 Case height: 130 mm Single piece weight: 2 kg Case weight: 20 kg	MS 402 Pack: thermo-retractable pack Couples: 5 Case height: 130 mm Single piece weight: 2.3 kg Case weight: 23 kg
---	---

DIMENSIONS AND LOADING CAPACITY

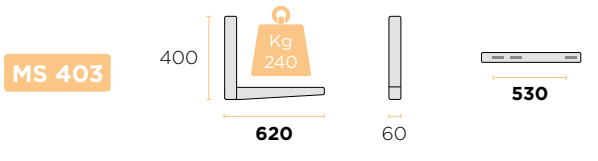
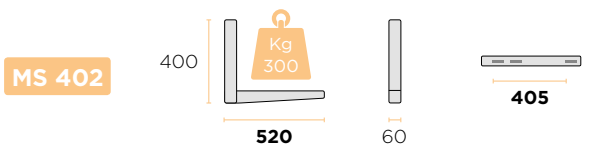
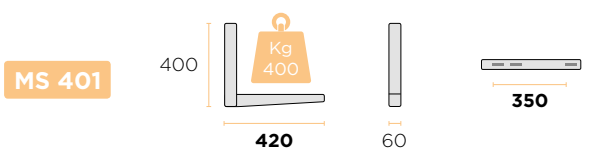

BRACKET DRILLING DIAGRAM

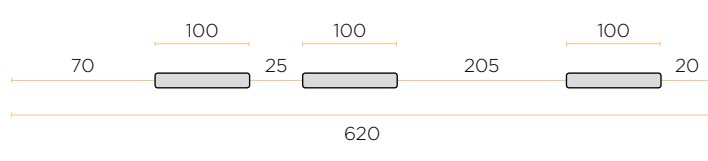
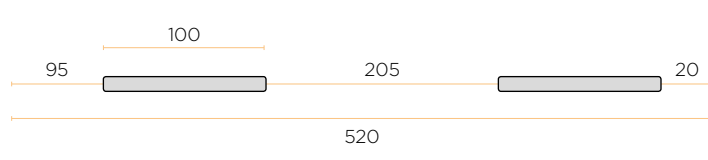
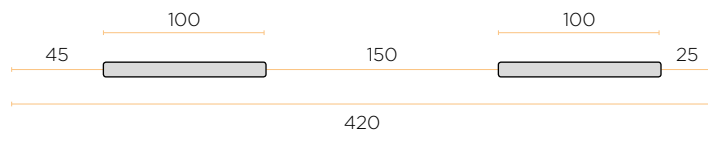

PALLET

MS 401 Pallet dimensions: 120x80x100 cm Couples per pallet: 70 Pallet total weight: 300 kg	MS 402 Pallet dimensions: 120x80x100 cm Couples per pallet: 70 Pallet total weight: 350 kg
---	---

MS 403
Pallet dimensions: 120x80x100 cm
Couples per pallet: 70
Pallet total weight: 380 kg



MATERIALS AND TREATMENT

Material: pickled steel
Frist treatment: electro galvanized
Second treatment: epoxy resins in polyester for outdoor
Colour: Ral 9002

BOX

MS 404	MS 405
Pack: thermo-retractable pack	Pack: thermo-retractable pack
Couples: 1	Couples: 1
Case height: 65 mm	Case height: 65 mm
Single piece weight: 3 kg	Single piece weight: 4.5 kg
Case weight: 6 kg	Case weight: 9 kg

MS 406
Pack: thermo-retractable pack
Couples: 1
Case height: 65 mm
Single piece weight: 2.7 kg
Case weight: 5.4 kg

PALLET

MS 404	MS 405
Pallet dimensions: 120x80x100 cm	Pallet dimensions: 120x80x100 cm
Couples per pallet: 30	Couples per pallet: 13
Pallet total weight: 300 kg	Pallet total weight: 117 kg

MS 406
Pallet dimensions: 120x80x100 cm
Couples per pallet: 45
Pallet total weight: 420 kg



DIMENSIONS AND LOADING CAPACITY

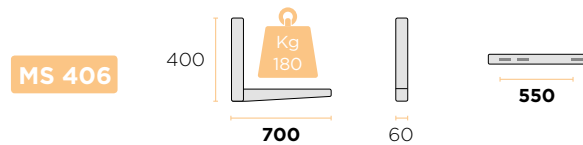
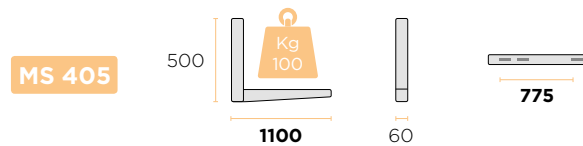
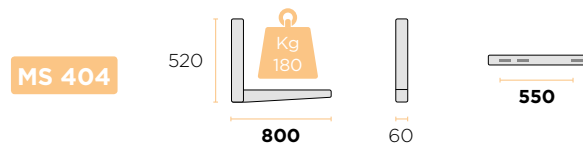

BRACKET DRILLING DIAGRAM

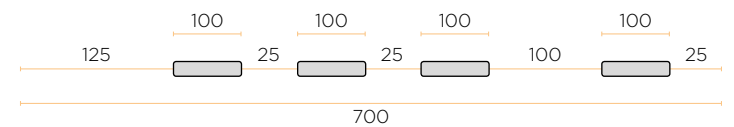
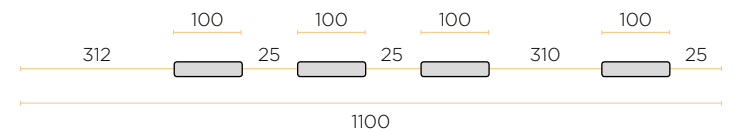
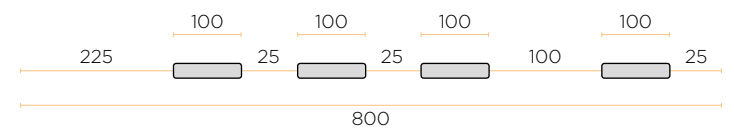



MATERIALS AND TREATMENT

Material: pickled steel
Frist treatment: electro galvanized
Second treatment: epoxy resins in polyester for outdoor
Colour: Ral 9002

BOX

MS 501	MS 502
Pack: thermo-retractable pack	Pack: thermo-retractable pack
Couples: 5	Couples: 5
Case height: 170 mm	Case height: 170 mm
Single piece weight: 2.6 kg	Single piece weight: 3.1 kg
Case weight: 26 kg	Case weight: 31 kg

PALLET

MS 501	MS 502
Pallet dimensions: 120x80x100 cm	Pallet dimensions: 120x80x100 cm
Couples per pallet: 60	Couples per pallet: 60
Pallet total weight: 300 kg	Pallet total weight: 350 kg

DIMENSIONS AND LOADING CAPACITY

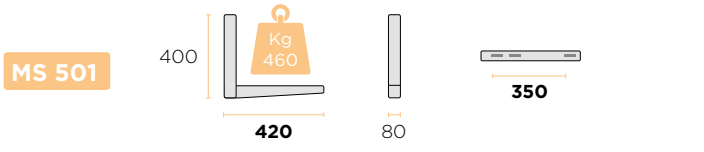

BRACKET DRILLING DIAGRAM

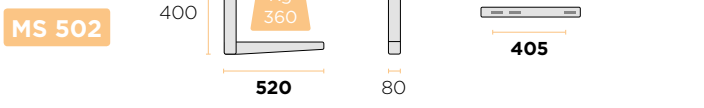



MATERIALS AND TREATMENT

Material: pickled steel
Frist treatment: electro galvanized
Second treatment: epoxy resins in polyester for outdoor
Colour: Ral 9002

BOX

MS 503	MS 504
Pack: thermo-retractable pack	Pack: thermo-retractable pack
Couples: 5	Couples: 1
Case height: 170 mm	Case height: 80 mm
Single piece weight: 3.5 kg	Single piece weight: 3.9 kg
Case weight: 35 kg	Case weight: 8 kg

MS 505
Pack: thermo-retractable pack
Couples: 1
Case height: 80 mm
Single piece weight: 7 kg
Case weight: 14 kg

PALLET

MS 503	MS 504
Pallet dimensions: 120x80x100 cm	Pallet dimensions: 120x80x100 cm
Couples per pallet: 60	Couples per pallet: 24
Pallet total weight: 400 kg	Pallet total weight: 200 kg

MS 505
Pallet dimensions: 120x80x100 cm
Couples per pallet: 9



DIMENSIONS AND LOADING CAPACITY

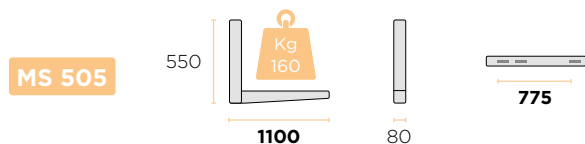
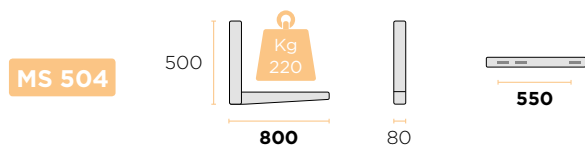
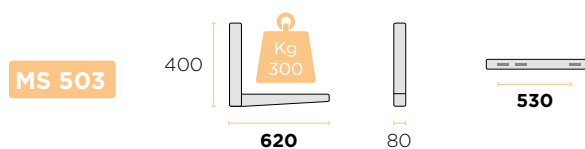

BRACKET DRILLING DIAGRAM

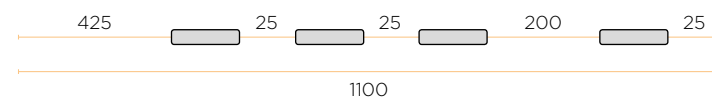
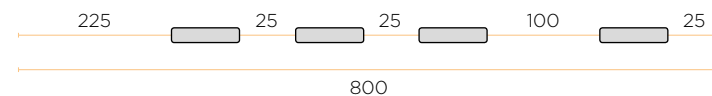
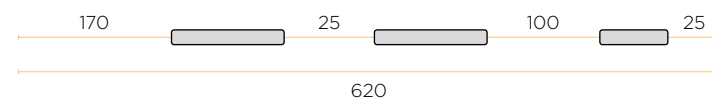

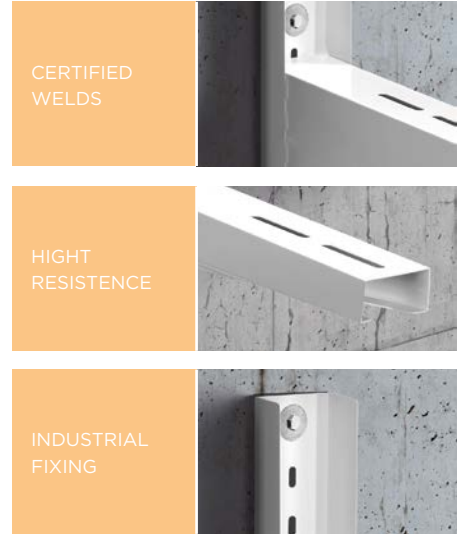

DIMENSIONS AND LOADING CAPACITY

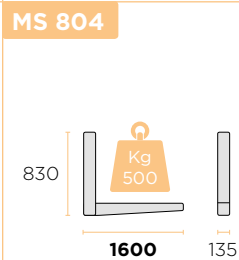
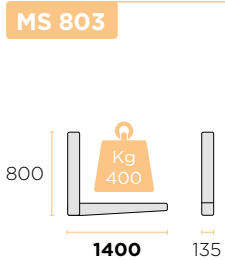
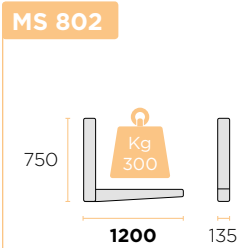
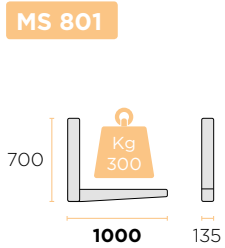

BRACKET DRILLING DIAGRAM

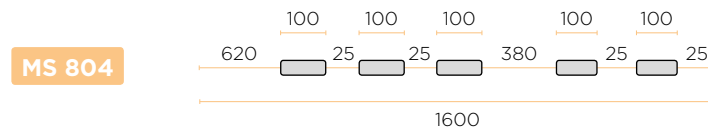
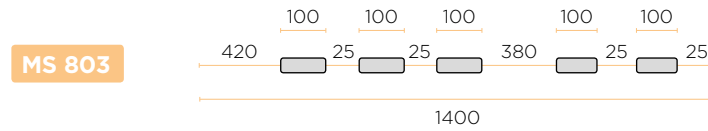
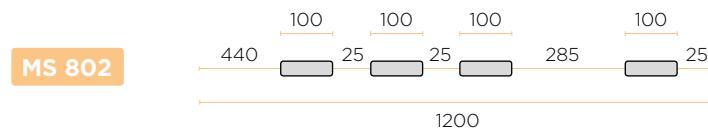
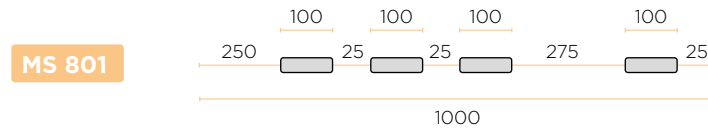

MATERIALS AND TREATMENT

Material: pickled steel
Frist treatment: electro galvanized
Second treatment: epoxy resins in polyester for outdoor
Colour: Ral 9002

BOX

Pack: thermo-retractable pack
Couples: 1
Case height: 150 mm

PALLET

Pallet dimensions: 120x80x100 cm



MATERIALS AND TREATMENT

Material: AISI 304 stainless steel plate
Treatment: epoxy resins in polyester on request
Colour: Natural/Ral 9002

BOX

MS 111
Pack: thermo retractable pack
Couples: 10
Single piece weight: 1.9 kg
Case weight: 19 kg

MS 112
Pack: thermo retractable pack
Couples: 10
Single piece weight: 1.9 kg
Case weight: 19 kg

MS 150
Pack: thermo retractable pack
Couples: 5
Single piece weight: 2.10 kg
Case weight: 21 kg

MS 151
Pack: thermo retractable pack
Couples: 5
Single piece weight: 2.60 kg
Case weight: 26 kg

PALLET

MS 111
Pallet dimensions: 120x80x100 cm
Couples per pallet: 200
Pallet total weight: 480 kg

MS 112
Pallet dimensions: 120x80x100 cm
Couples per pallet: 200
Pallet total weight: 480 kg

MS 150
Pallet dimensions: 120x80x130 cm
Couples per pallet: 70
Pallet total weight: 350 kg

MS 151
Pallet dimensions: 120x80x100 cm
Couples per pallet: 90
Pallet total weight: 450 kg



DIMENSIONS AND LOADING CAPACITY

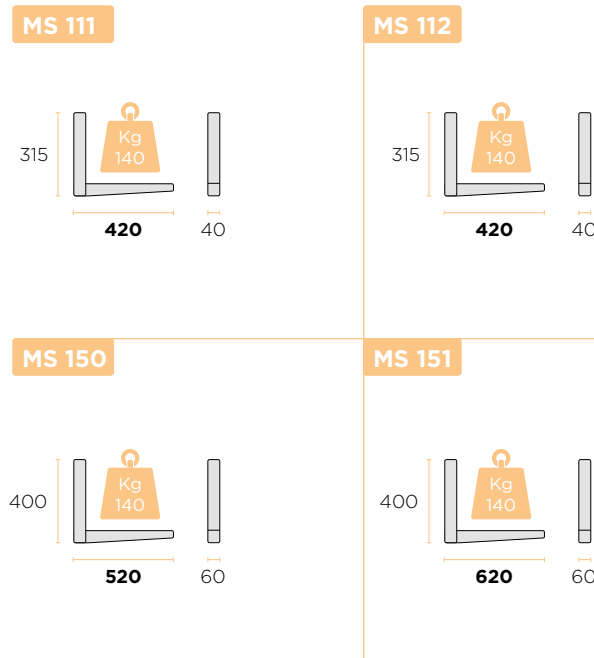

BRACKET DRILLING DIAGRAM

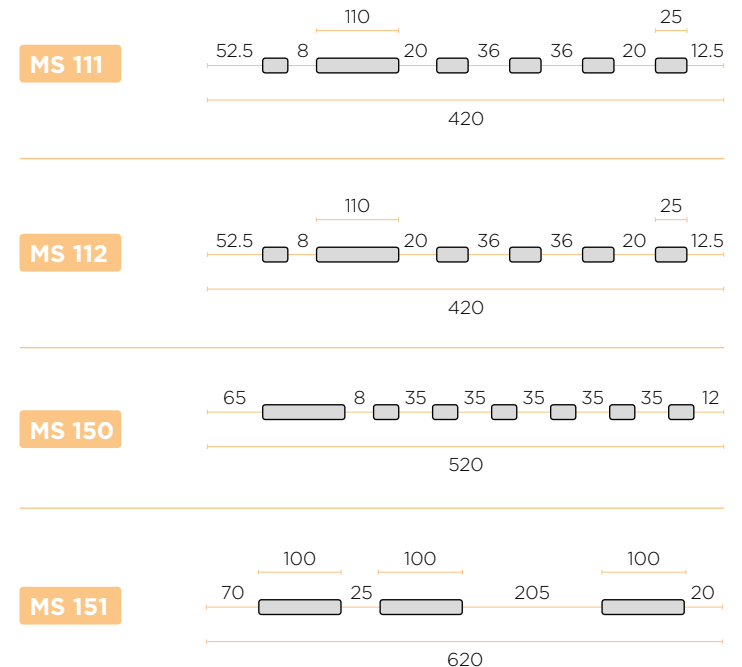



Management System
 ISO 9001:2008
 www.tuv.com
 ID 9195673334



MATERIALS AND TREATMENT

Material: pickled steel
Treatment: epoxy resins in polyester for outdoor
Colour: Ral 9002

LOAD CAPACITY

Domestic use: 140 Kg
Load testing weight: 420 Kg

BOX

Pack: thermo-retractable pack
Couples: 20
Case height: 200 mm
Single piece weight: 1.12 Kg
Case weight: 45 Kg

PALLET

Pallet dimensions: 120x80x100 cm
Couples per pallet: 200 kg
Pallet total weight: 480 kg

DIMENSIONS AND LOADING CAPACITY

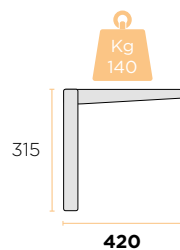

BRACKET DRILLING DIAGRAM

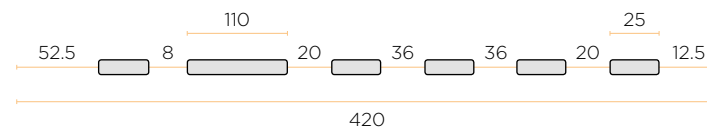



MATERIALS AND TREATMENT

Material: pickled steel
Treatment: epoxy resins in polyester for outdoor
Colour: Ral 9002

LOAD CAPACITY

Domestic use: 140 Kg
Load testing weight: 420 Kg

BOX

MV 105 Pack: thermo-retractable pack Couples: 20 Case height: 200 mm Single piece weight: 1.12 kg Case weight: 45 kg	MV 106 Pack: thermo-retractable pack Couples: 12 Case height: 165 mm Single piece weight: 1.32 kg Case weight: 32 kg
---	---

PALLET

MV 105 Pallet dimensions: 120x80x100 cm Couples per pallet: 200 Pallet total weight: 480 kg	MV 106 Pallet dimensions: 120x80x100 cm Couples per pallet: 168 Pallet total weight: 350 kg
--	--



DIMENSIONS AND LOADING CAPACITY

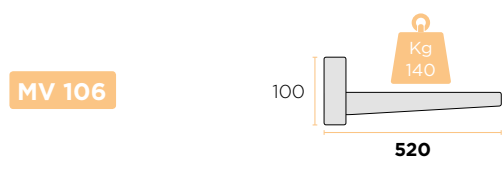
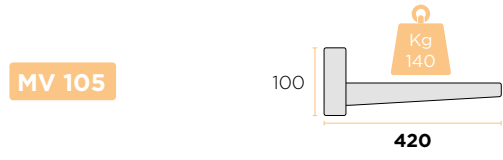

BRACKET DRILLING DIAGRAM

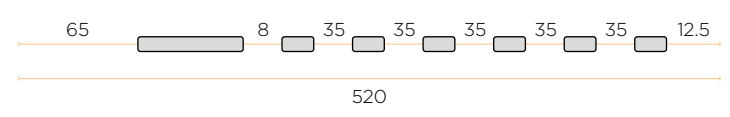
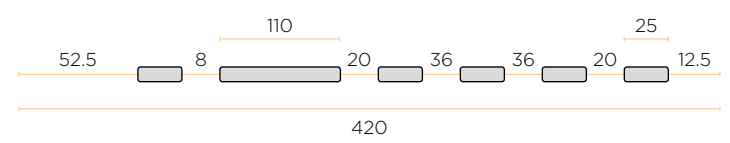



A close-up photograph of a metal roof bracket assembly. A silver bolt is visible on the left side of a metal plate. The plate is attached to a perforated metal beam. The background is a solid light green color.

ROOF BRACKETS
MENSOLE DA TETTO

OOOF

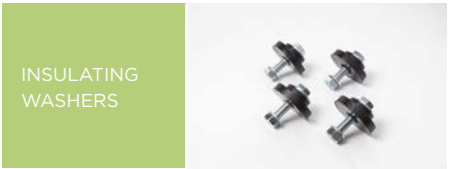
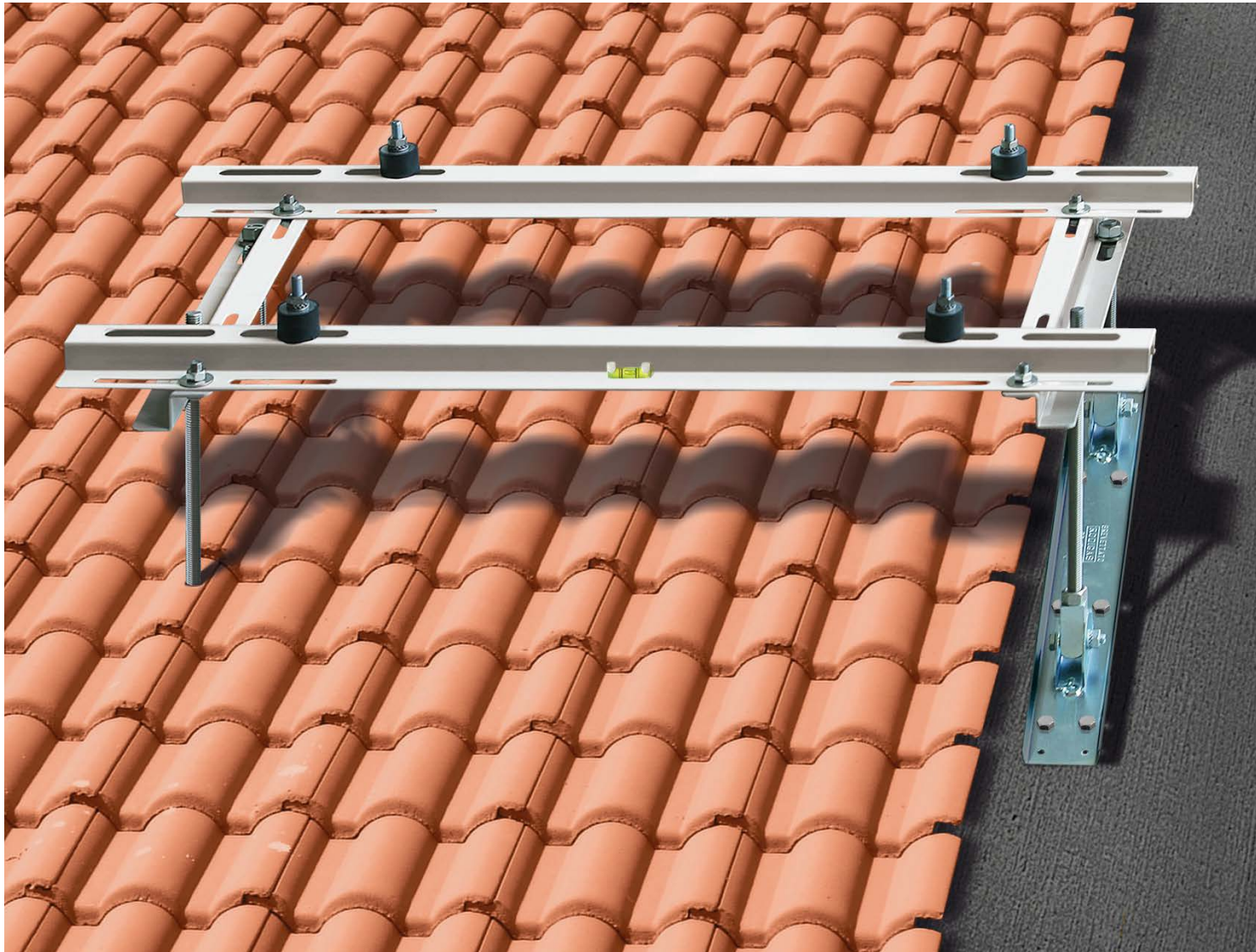

Management System
ISO 9001:2008
www.tuv.com
ID 910872334



MATERIALS AND TREATMENT

- Material:** electro-galvanised steel
- Treatment:** epoxy resins in polyester for outdoor
- Colour:** Ral 9002
- Adjustable bars:** M12 stainless steel threaded stumps
- Bolts and nuts:** stainless steel



LOAD CAPACITY

- Domestic use:** 140 Kg
- Load testing weight:** 420 Kg



BOX

- Pack:** carton box
- Pieces:** 1
- Pack dimensions:** 980x85x980 mm
- Case weight:** 5.0 kg



PALLET

- Pallet dimensions:** 106x106x100 cm
- Pieces per pallet:** 108
- Pallet total weight:** 550 kg



DIMENSIONS AND LOADING CAPACITY

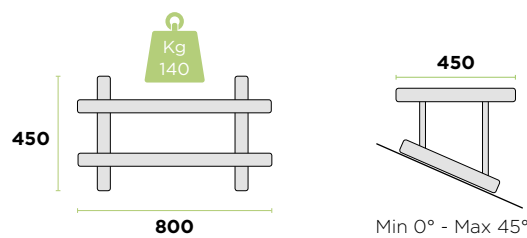

BRACKET DRILLING DIAGRAM

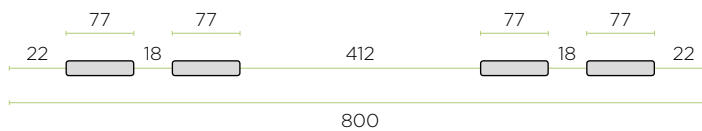

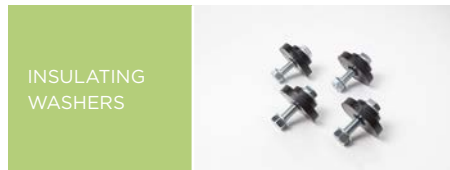

MATERIALS AND TREATMENT

Material: electro-galvanised steel
Treatment: epoxy resins in polyester for outdoor
Colour: Ral 9002
Inclination: Min 9° - Max 45°

LOAD CAPACITY

Domestic use: 140 Kg
Load testing weight: 420 Kg

BOX

Pack: carton box
Pieces: 1
Pack dimensions: 980x85x980 mm
Case weight: 5.0 kg

PALLET

Pallet dimensions: 106x106x100 cm
Pieces per pallet: 108
Pallet total weight: 550 kg

DIMENSIONS AND LOADING CAPACITY

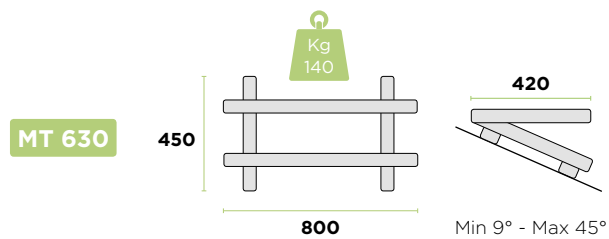

BRACKET DRILLING DIAGRAM

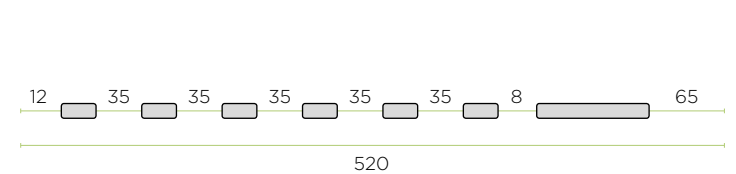
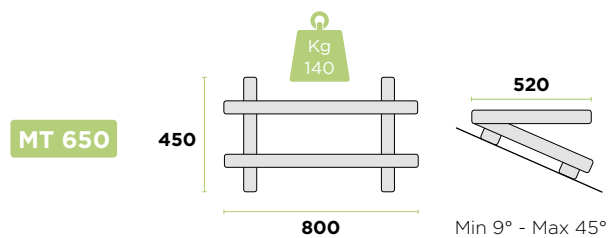
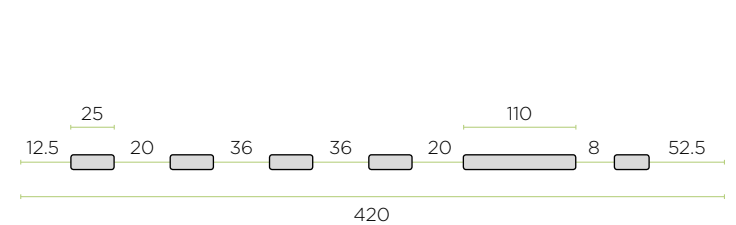

SSP

SPECIAL BRACKETS

MENSOLE SPECIALI

CHIALL



MATERIALS AND TREATMENT

Material: steel
Treatment: epoxy resins in polyester for outdoor
Colour: Ral 9002

LOAD CAPACITY

Domestic use: 140 Kg
Load testing weight: 420 Kg

BOX

Pack: nylon packaging
Couples: 1
Pack dimensions: 800x420x50 mm
Working height: 560 mm
Case weight: 8.2 Kg

DIMENSIONS AND LOADING CAPACITY

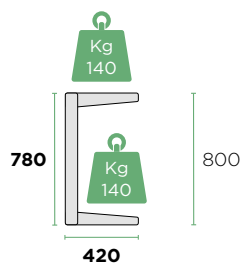

Other dimensions available on request

BRACKET DRILLING DIAGRAM

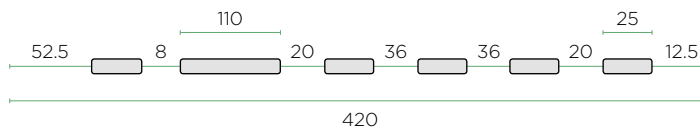

PERMANENT
MARKING



CERTIFIED
WELDS



Management
System
ISO 9001:2008



www.tuv.com
ID 910507334



MATERIALS AND TREATMENT

Material: steel
Treatment: epoxy resins in polyester for outdoor
Colour: Ral 9002



LOAD CAPACITY

Domestic use: 140 Kg
Load testing weight: 420 Kg



BOX

Pack: nylon packaging
Pieces: 1
Pack dimensions: 700x420x50 mm



DIMENSIONS AND LOADING CAPACITY

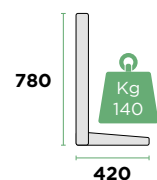

Other dimensions available
on request



BRACKET DRILLING DIAGRAM

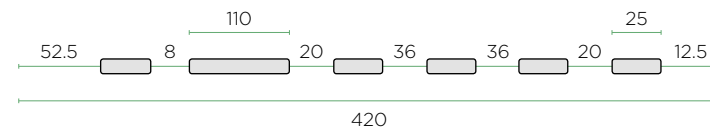



Management System
ISO 9001:2008
www.tuv.com
ID 910673334



MATERIALS AND TREATMENT

Material: steel

Treatment: epoxy resins in polyester for outdoor

Colour: Ral 9002



BOX

MS 105 SC1

Couples: 1

Pack width: 330 mm

Pack length: 460 mm

Pack height: 50 mm

MS 125 SC1

Couples: 1

Pack width: 430 mm

Pack length: 470 mm

Pack height: 55 mm

MS 106 SC1

Couples: 1

Pack width: 430 mm

Pack length: 580 mm

Pack height: 55 mm



PALLET

MS 105 SC1

Pallet dimensions: 120x80x200 cm

Pieces per pallet: 200

MS 125 SC1

Pallet dimensions: 120x80x200 cm

Pieces per pallet: 152

MS 106 SC1

Pallet dimensions: 120x80x200 cm

Pieces per pallet: 128



BRACKET DRILLING DIAGRAM

MS 105 SC1 - MS 125 SC1

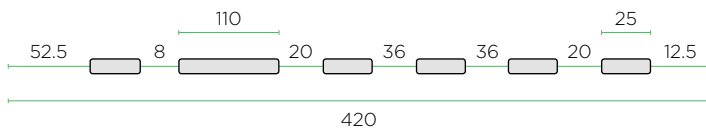

MS 106 SC1

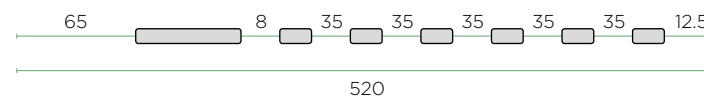

WALL
FIXING KIT



INSULATING
WASHERS



LEVELLING
SYSTEM



Management
System
ISO 9001:2008
www.rodigas.com
ID: 8102072824



MATERIALS AND TREATMENT

Material: electro-galvanised steel plate

Treatment: epoxy resins in polyester
for outdoor

Colour: Ral 9002

Joint: high resistant screw M6x70 8.8

Adjustment: 2 adjustable gummy
polypropilene feet (patented)



BOX

MF 220 - MF 221

Pack: carton box

Pieces: 1

Pack dimensions: 970x85x90 mm

Case weight: 4.84 kg



PALLET

MF 220 - MF 221

Pallet dimensions: 106x106x100 cm

Pieces per pallet: 108 kg

Pallet total weight: 540 kg



DIMENSIONS AND LOADING CAPACITY

MF 220

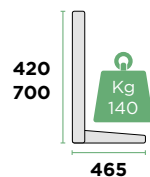

MF 221

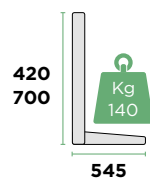

BRACKET DRILLING DIAGRAM

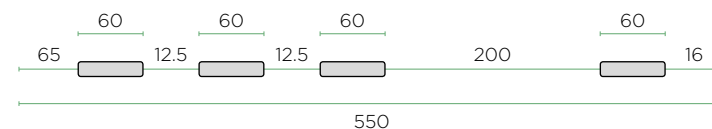
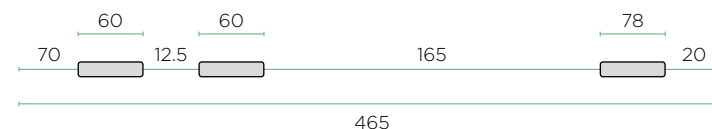



Management System
ISO 9001:2008
www.tuv.com
ID 9105673334



MATERIALS AND TREATMENT

Material: steel
Treatment: epoxy resins in polyester for outdoor
Colour: Ral 9002



LOAD CAPACITY

Domestic use: 140 Kg
Load testing weight: 420 Kg



BOX

Pack: 1 couple
Pack width: 430 mm
Pack length: 580 mm
Case height: 55 mm



PALLET

Pallet dimensions: 100x120x190 cm
Pieces per pallet: 128



DIMENSIONS AND LOADING CAPACITY

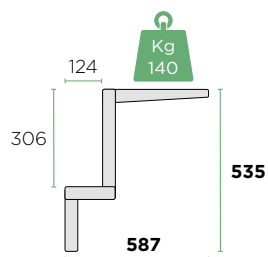

BRACKET DRILLING DIAGRAM

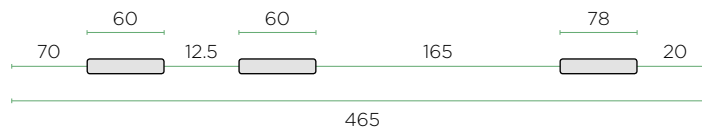



EXAMPLE OF INSTALLATION

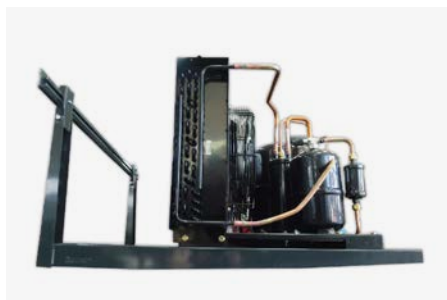

EXAMPLE OF INSTALLATION



MATERIALS AND TREATMENT

Vertical rod material: extruded aluminium alloy
Material: electro-galvanised steel plate
Treatment: epoxy resins in polyester for outdoor
Colour: Ral 9002
Joint: high resistant screw M8x80 8.8
Adjustment: 4 adjustable gummy polypropilene feet (patented)

BOX

Pack: carton box
Pieces: 1 couple

DIMENSIONS AND LOADING CAPACITY

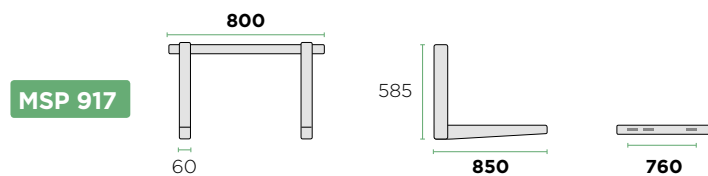
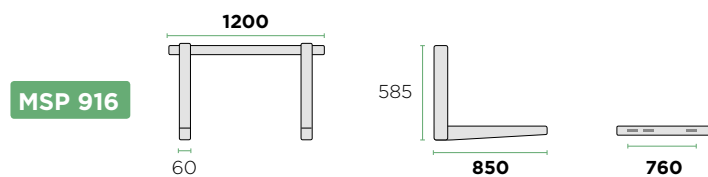
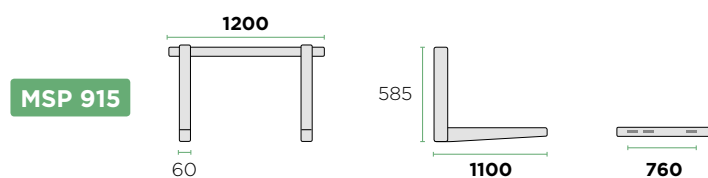

BRACKET DRILLING DIAGRAM

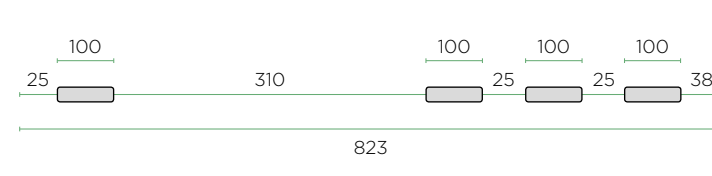
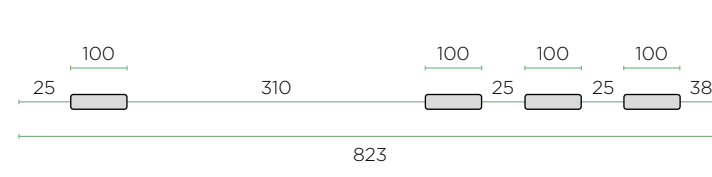
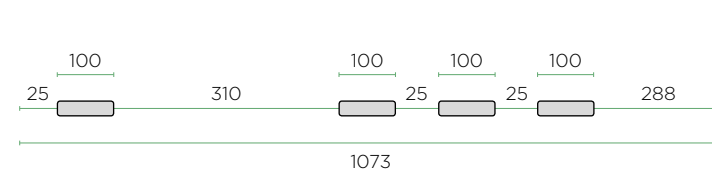

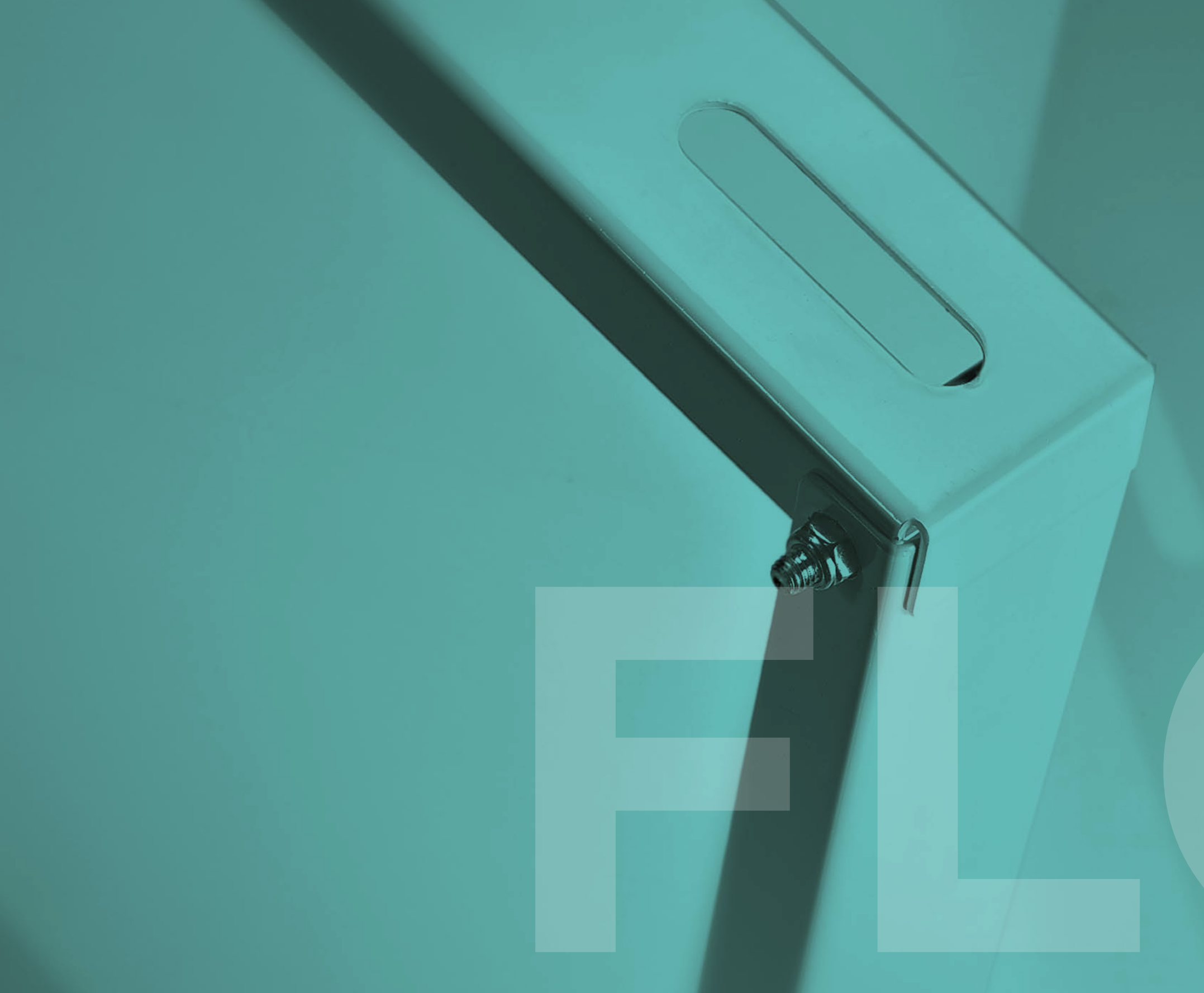

FILE

FLOOR SUPPORTS

> PVC > Steel > Modular > Single

SUPPORTI PAVIMENTO

> *PVC* > *Lamiera* > *Componibile* > *Singolo*

COOR



TECHNICAL CHARACTERISTICS

Material: Hard PVC self-extinguishing VO

SP series equipped with:
4 fixing elements M 10
4 sticky vibroflex

SPE series equipped with:
4 fixing elements M 10

AVAILABLE ACCESSORIES

TS
Front cap height: 100 mm
Case: 24 pieces

TSE
Front cap height: 80 mm
Case: 24 pieces



DIMENSIONS AND LOADING CAPACITY

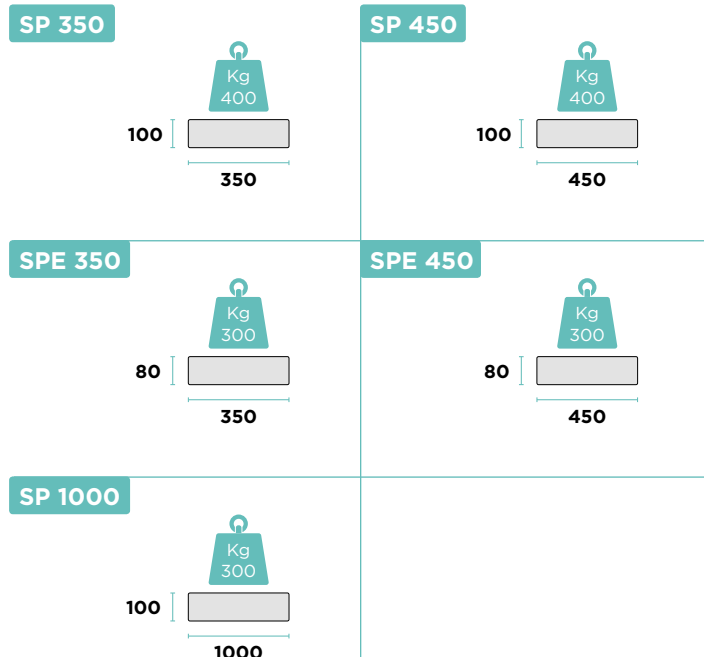

BOX

CODE	CASE	PIECES	CASE DIMENSIONS	CASE WEIGHT
SP 350	Carton case	24	370x560x430	14.5 kg
SP 450	Carton case	24	470x560x430	18.5 kg
SPE 350	Carton case	24	360x450x350	10 kg
SPE 450	Carton case	24	460x460x350	13 kg
SP 1000	Carton case	4	103x21x21	8 kg



PALLET

Pallet dimensions: 120x80x100 cm

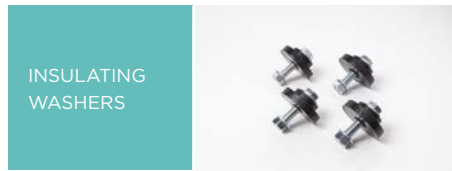

TECHNICAL CHARACTERISTICS

Material: galvanized steel
Colour: Ral 9002
Equipped with: vibration dampers and no slip washers
Case: 1 couple

BOX

CODE	CASE	PIECES
SP 635	Carton case	10
SP 645	Carton case	10

PALLET

Pallet dimensions: 120x80x100 cm



DIMENSIONS AND LOADING CAPACITY

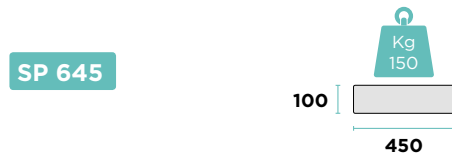

SUPPORT DRILLING DIAGRAM

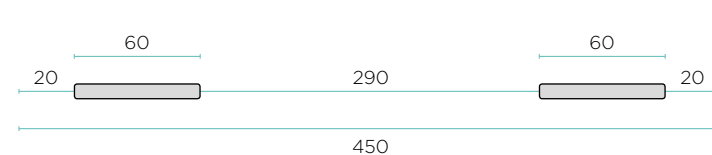
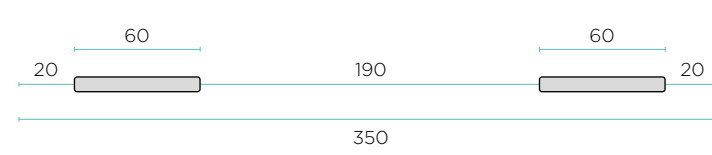

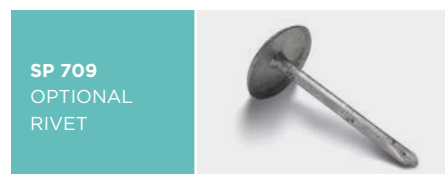
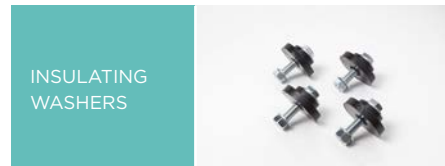

TECHNICAL CHARACTERISTICS

- Material:** galvanized steel
- Colour:** Ral 9002
- Equipped with:** vibration dampers and assembling screws
- Case:** 1 couple
- Pieces per pallet:** 170
- Extension:**
- Min L=** 480 mm
- Max L=** 830 mm

LOAD CAPACITY

Domestic use: 200 Kg

DIMENSIONS AND LOADING CAPACITY

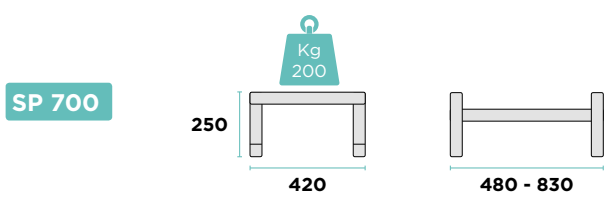

SUPPORT DRILLING DIAGRAM

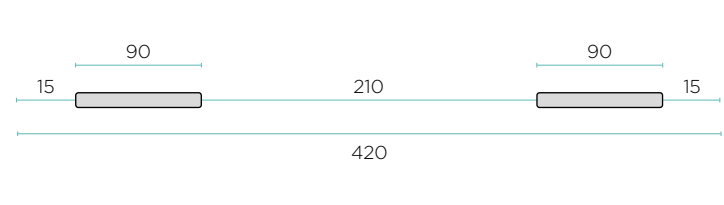
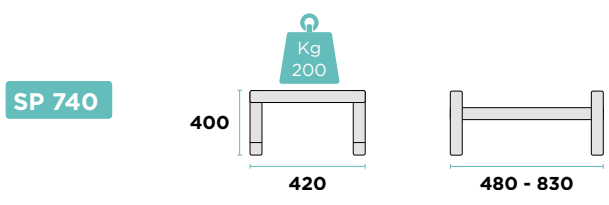
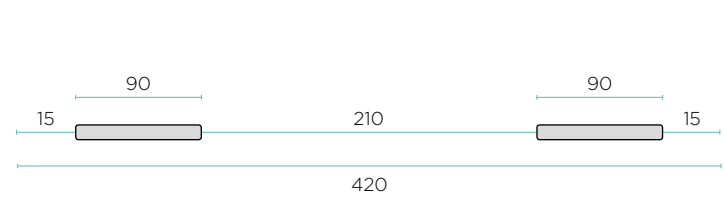

INSULATING
WASHERS



AV 740
OPTIONAL
FEET
DAMPERS



SP 709
OPTIONAL
RIVET



Management
System
ISO 9001:2008
www.buc.com
ID 9106073334



TECHNICAL CHARACTERISTICS

Material: stainless steel

Colour: Ral 9002

Equipped with: vibration dampers and assembling screws

Case: 1 couple

Pieces per pallet: 170

Extension:

Min L= 480 mm

Max L= 830 mm



LOAD CAPACITY

Domestic use: 200 Kg

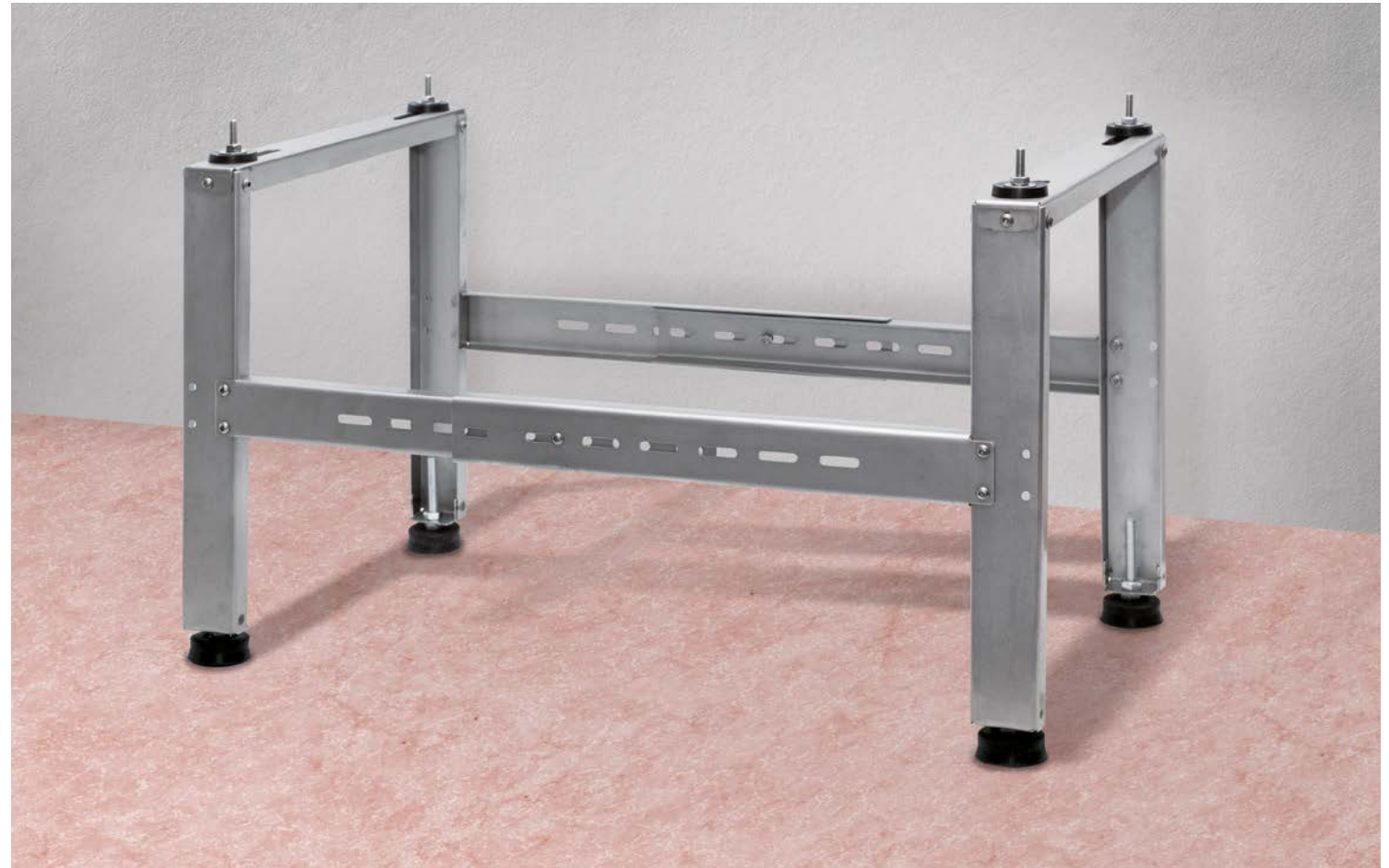

DIMENSIONS AND LOADING CAPACITY

SP 701

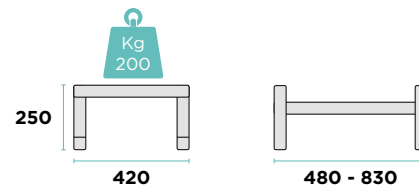

SUPPORT DRILLING DIAGRAM

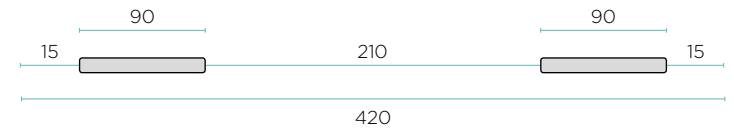

SP 741

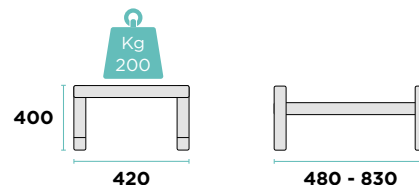



INSULATING
WASHERS



AV 740
OPTIONAL
FEET
DAMPERS



SP 709
OPTIONAL
RIVET



Management
System
ISO 9001:2008
www.tuv.com
ID: 9105073334



TECHNICAL CHARACTERISTICS

Material: galvanized steel

Colour: Ral 9002

Equipped with: vibration dampers and assembling screws

Case: 1 couple

Extension:

Min L= 480 mm

Max L= 830 mm



DIMENSIONS AND LOADING CAPACITY

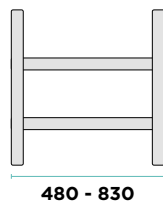
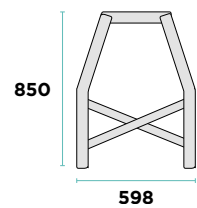

SUPPORT DRILLING DIAGRAM

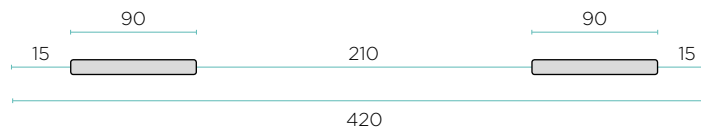

LOAD CAPACITY

Domestic use: 200 Kg

ANTI
VIBRATION



NO SLIP
SYSTEM



Management
System
ISO 9001:2008



www.rodigas.com
ID 9105073334



TECHNICAL CHARACTERISTICS

Material: PVC

Equipped with: antivibration and no slip washers or gummy ring

Case: 12 kit x 4 pcs



DIMENSIONS AND LOADING CAPACITY

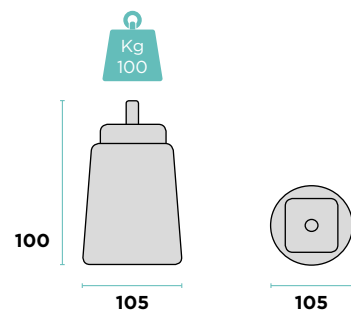

TECHNICAL CHARACTERISTICS

Description: plastic floor support suitable for terrace and balcony. With this item we can warranty good ventilation, and easy cleaning of the surface.



LOAD CAPACITY

Domestic use: 400 Kg



DAMI





VIBRATION DAMPERS

ANTIVIBRANTI

PEERS

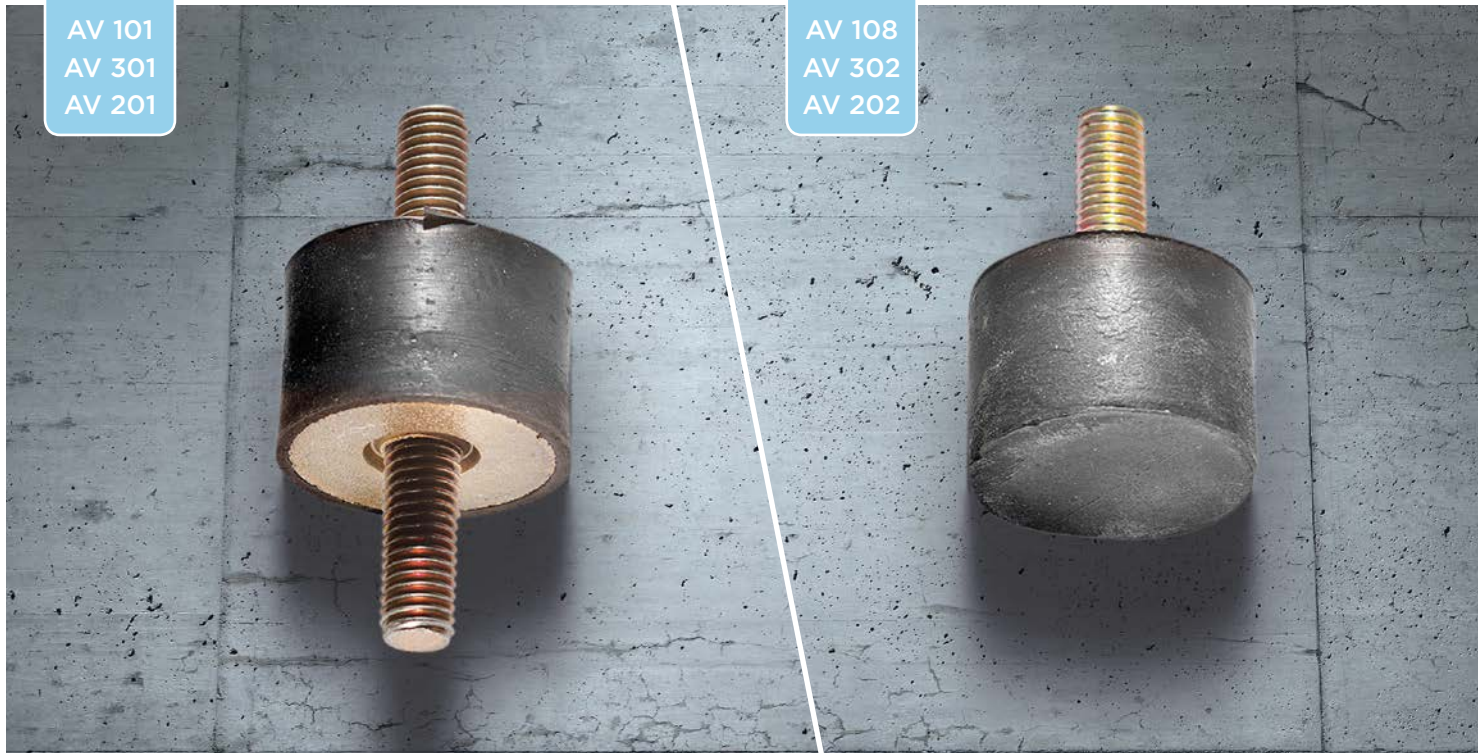

PRODUCT DESCRIPTION

Material: rubber

Hardness: 50 shore

Resistance to temperature: -40° +60° C



BOX

Pack: blister in nylon

Pack width: 4 anti-vibration pieces + bolts and nuts

Multi-pack: 50 kit

Box dimension: 40x20x20 cm



DIMENSIONS

AV 101

AV 301

AV 201

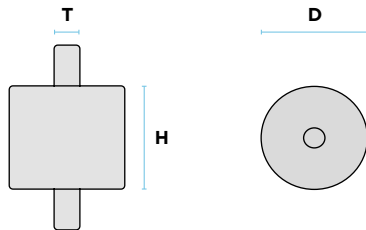

AV 108

AV 302

AV 202

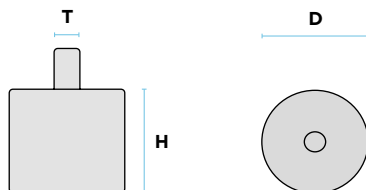

VIBRATION DAMPERS KIT DATA

CODE	DIAMTER	HEIGHT	THREAD
AV 101	30 mm	20 mm	2x M 8x20
AV 301	40 mm	30 mm	2x M 8x20
AV 201	40 mm	40 mm	2x M 8x20
AV 401	50 mm	40 mm	2x M 10x20

VIBRATION FEET DAMPERS KIT DATA

CODE	DIAMTER	HEIGHT	THREAD
AV 108	30 mm	20 mm	1x M 8x20
AV 302	40 mm	30 mm	1x M 8x20
AV 202	40 mm	40 mm	1x M 8x20
AV 402	50 mm	40 mm	1x M 10x20

INOX VIBRATION FEET DAMPERS

CODE	DIAMTER	HEIGHT	THREAD
AV 102	30 mm	20 mm	2x M 8x20



PRODUCT DESCRIPTION

Material: rubber
Hardness: 50 shore
Resistance to temperature: -40° +60° C



BOX

Pack: blister in nylon
Pack width: 4 vibration dampers + bolts and nuts
Multi-pack: 50 kit
Box dimension: 40x20x20 cm



DIMENSIONS

AV 111

AV 311

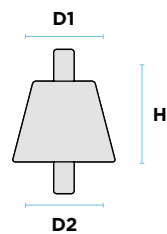

AV 210

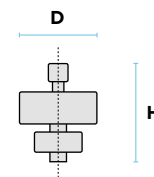

AV 105

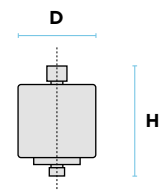

VIBRATION DAMPERS KIT DATA

CODE	DIAMTER 1	DIAMTER 2	HEIGHT	THREAD
AV 111	28 mm	40 mm	20 mm	2x M 8x20
AV 311	32 mm	40 mm	30 mm	2x M 8x20

THROUGH SCREW KIT BASIC DATA

CODE	DIAMTER	HEIGHT	THREAD
AV 210	40 mm	7 mm	M 8x40
AV 105	30 mm	25 mm	M 8x50



CONDE

CONDENSATE DRAINAGE SET

> Embedding Box > Trays > Universal Fitting > Pipes > Pump

SCARICO CONDENSA

> *Scatola* > *Vaschette* > *Raccordi* > *Tubi* > *Pompe*

CONDENSATE

PB 300

Embedding box in plastic

The embedding box is the first embedded box with "pouch" studied specifically for air conditioning employment.

Thanks to the patented solutions, it is the only box that doesn't need cross girders as reinforcement to avoid any deformation; the cover is in fact equipped with very strong small plates used for fixing of the template of the conditioner. The material of this box allows to support any effort caused by the installation works and the pouch also excludes the necessity of substitution even in case of damage.

The optional cover from outdoor CP300 is an unique body with the box and, for this reason, it makes unnecessary the application of an external systems of alignment (as required in other types of boxes); beside it protects the inside part of box during the building works. The box was introduced in the market on 1996, it had further implementations that allow a large diffusion and the constant success.

PB 300

Scatola di predisposizione in plastica

La prima scatola con marsupio studiata appositamente per il condizionamento.

Grazie ai suoi brevetti, è l'unica scatola che non ha bisogno di traversini di rinforzo antideformazione, perché il coperchio è dotato di placchette molto robuste da utilizzare nel fissaggio della dima del condizionatore. Il materiale di realizzazione è in grado di supportare qualsiasi sforzo dovuto alla messa in opera muraria ed il gocciolatoio esclude la necessità di sostituzione anche in caso di danneggiamento. Il coperchio da cantiere CP300 opzionale è un corpo unico con la scatola, che rende inutile l'applicazione di sistemi esterni di allineamento (di cui necessitano invece altri tipi di scatole) proteggendo anche l'interno scatola in fase di completamento delle opere murarie.

Nel lungo utilizzo dal 1996, quando è stata immessa nel mercato, fino ad oggi, ha subito ulteriori implementazioni che ne determinano il continuo successo e larga diffusione.



MULTIFUNCTIONAL COVER

Construction site optional cover to protect the inside of the box during the wall plastering. Once protected the pipes by the cover during the wall plastering, separate the two ending parts to fix the indoor unit template.

COPERCHIO DA CANTIERE

Questo robusto coperchio protegge l'interno della scatola e le tubazioni durante le fasi di intonacatura e finitura delle pareti. Separando le placchette alle estremità si riutilizzano in fase di installazione per il fissaggio della dima del condizionatore.



OUTER LID

Supplied with the box is possible use it before the installation of the internal unit

COPERCHIO ESTERNO

Fornito con la scatola è possibile utilizzarlo prima dell'installazione dell'unità interna.



FIXING PLATE

Is possible move in different position for fixing the installation plate

PLACCHE DI FISSAGGIO

È possibile spostarle in posizioni diverse per fissare la piastra di installazione

INTERNAL SPACE

Completely usable internal space thanks to the absence of stiffening bridges placed instead externally

SPAZIO INTERNO

Interno completamente sfruttabile grazie all'assenza di ponti per rinforzo posti esternamente

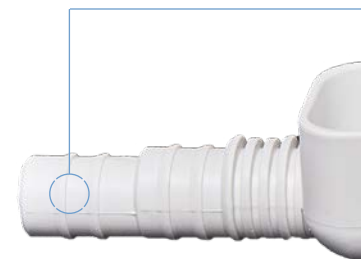
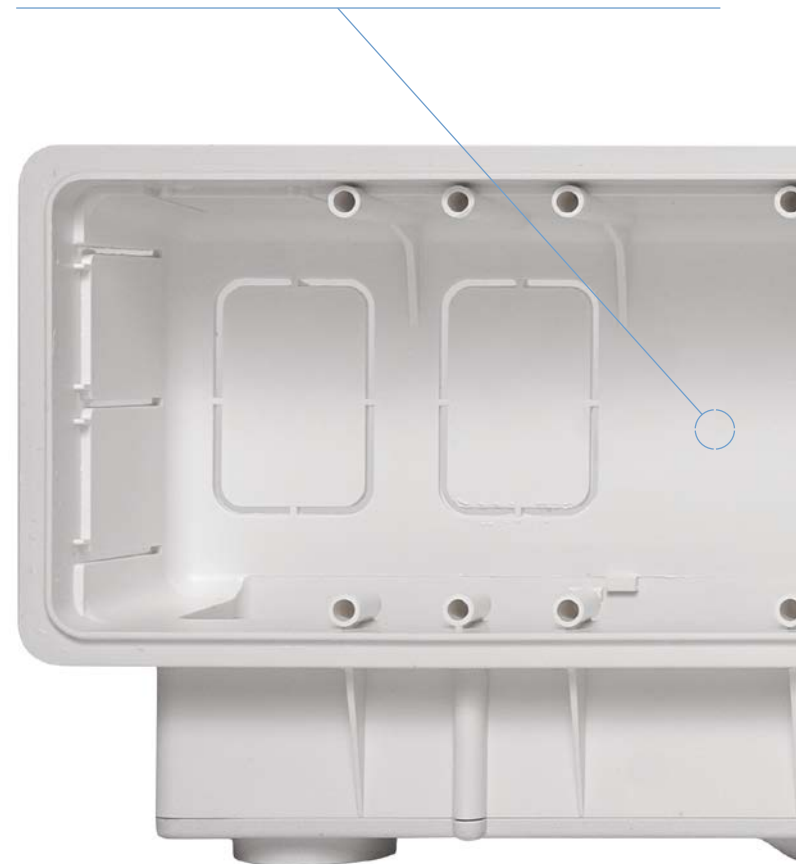

DISCHARGE ON TWO SIDES

Tub housed inside the box with inspectable hoses

SCARICO SU DUE LATI

Vaschetta alloggiata all'interno della scatola con manicotti ispezionabili

LEVELLING SYSTEM

Optional levelling system

SISTEMA DI LIVELLAMENTO

Sistema di livellamento opzionale

SUITABLE PREDRILLED HOLES

Predrilled holes positioned to allow the universal use

PREFORATURE IDONEE

Preisposizione all'uscita della tubazioni lateralmente o posteriormente

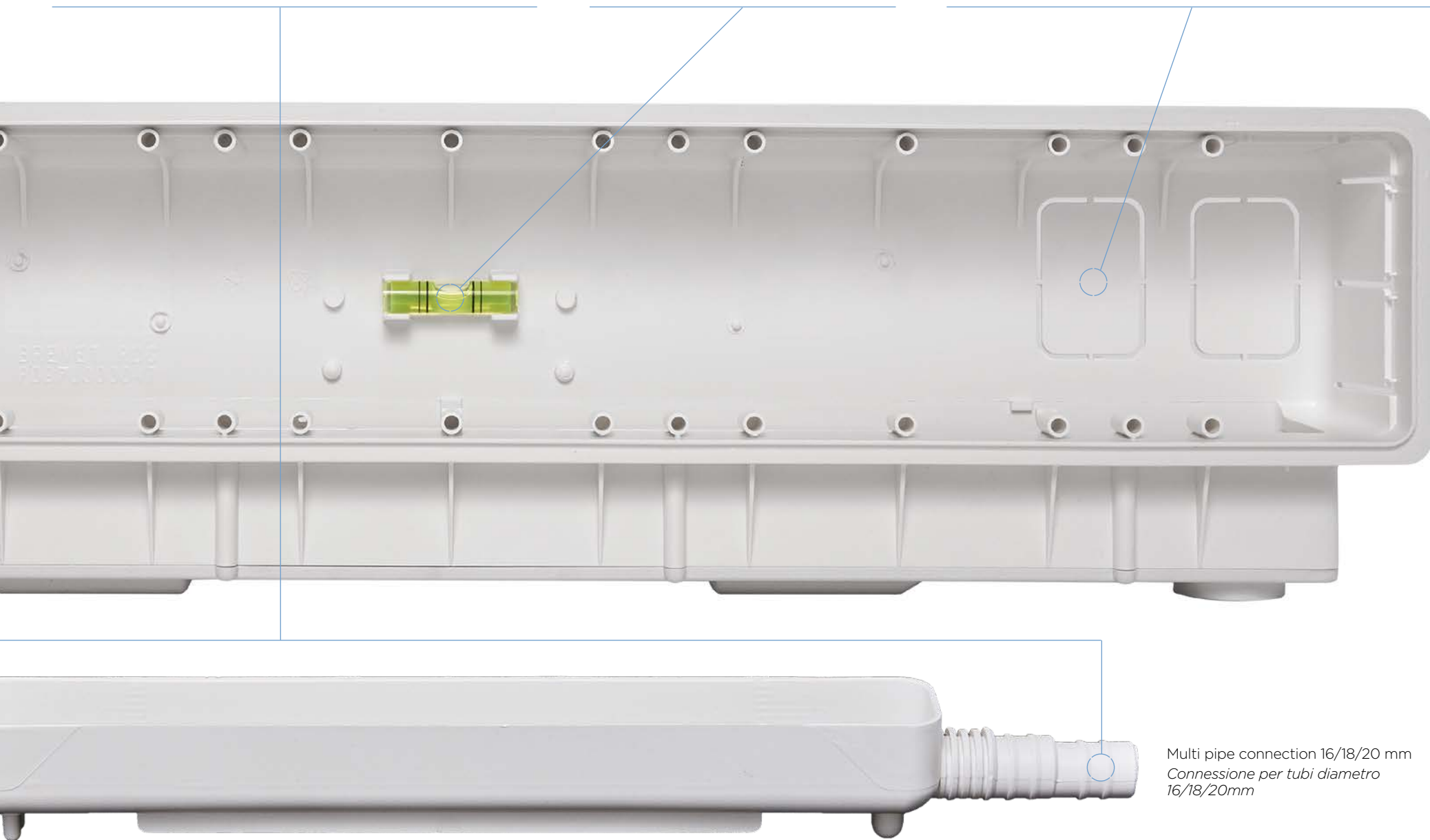

Multi pipe connection 16/18/20 mm
Connessione per tubi diametro
16/18/20mm

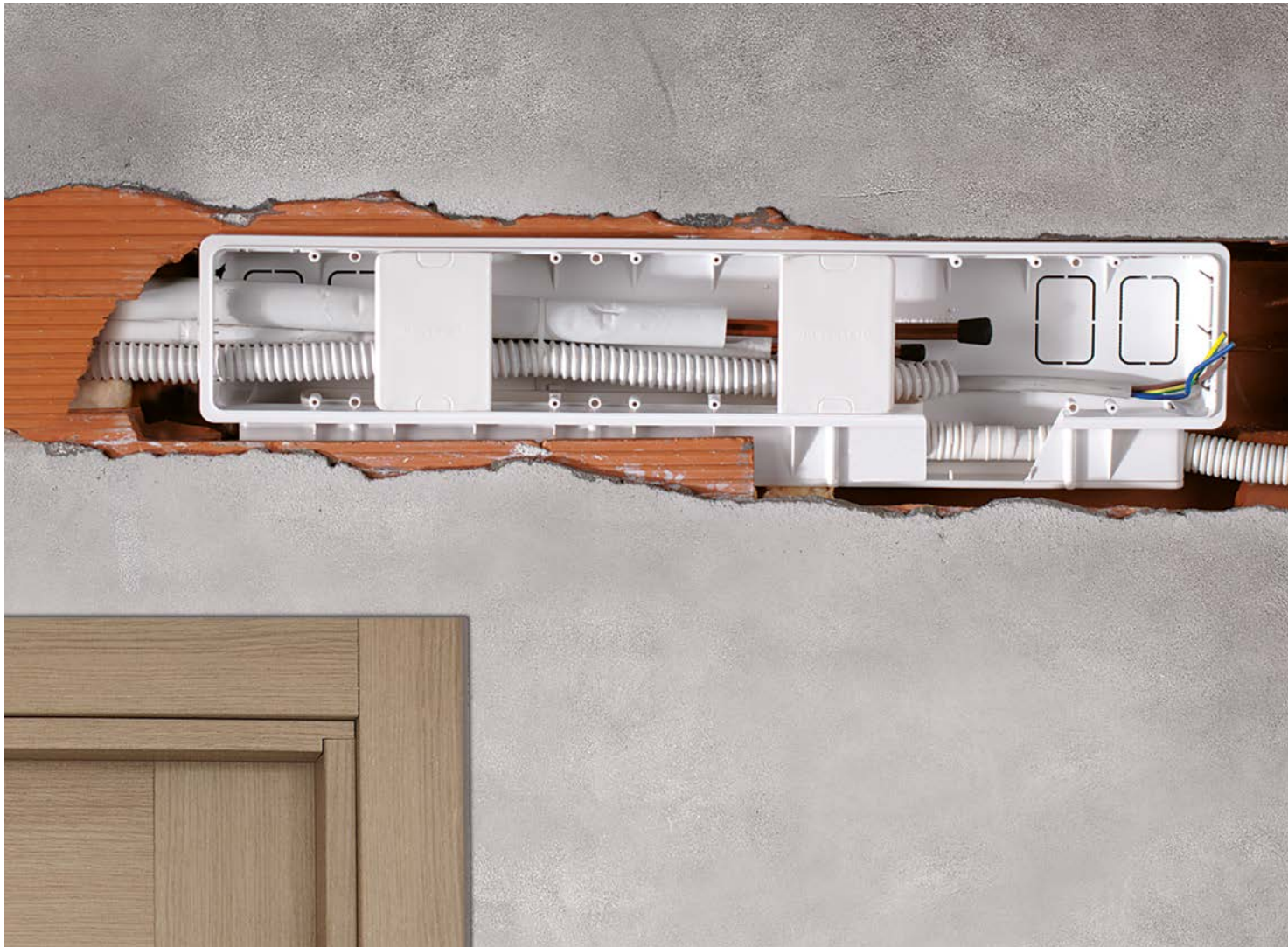

Management System
 ISO 9001:2008
 www.rodigas.com
 ID: 9106073334



GENERAL DATA AND MATERIALS

- Case length:** 540 mm
- Case height:** 130 mm
- Case width:** 65 mm
- Opening dimensions:** 525 x 80 mm
- Material supplied:** Finishing top cover
- Available accessories:** CP 300 Plastic yard cap, Box with 5 pcs



BOX

- Pack:** carton box
- Pieces:** 15
- Case dimensions:** 570x360x430 mm
- Case weight:** 12.5 Kg



DIMENSIONS

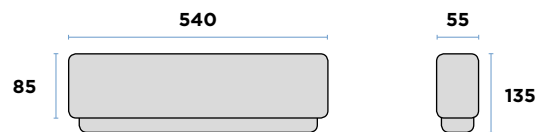

BOX WITH PS 106



PALLET

- Pallet dimensions:** 120x80x235 cm
- Couples per pallet:** 300
- Pallet total weight:** 250 kg



MULTIFUNCTIONAL COVER

Code: CP 300

Description: construction site optional cover to protect the inside of the box during the wall plastering. Once protected the pipes by the cover during the wall plastering, separate the two ending parts to fix the indoor unit template.

Descrizione: Coperchio da cantiere opzionale per proteggere l'interno della scatola durante l'intonacatura della parete. Una volta utilizzato il coperchio per proteggere le tubazioni in fase di intonacatura della parete si separano le due estremità e si utilizzano per il fissaggio della dima dell'unità interna.



MATERIALS AND TREATMENT

Material: plastic
Colour: white



BOX

Pack: nylon packaging
Pieces: 5 pcs



FIXING PLATE

Code: PB 300 P

Description: plates applicable to the box for fixing the external air conditioning unit.

Descrizione: Placchette applicabili alla scatola per il fissaggio della dima dell'unità esterna di condizionamento.



MATERIALS AND TREATMENT

Material: plastic
Colour: white



BOX

Pack: nylon packaging
Pieces: 30 pcs



LEVELING SYSTEM

Code: PB 300 L

Description: leveling system to be applied inside the box for a quick installation

Descrizione: sistema di livellamento da applicare all'interno della scatola per una corretta installazione di intonacatura della parete si separano le due estremità e si utilizzano per il fissaggio della dima dell'unità interna.



MATERIALS AND TREATMENT

Material: plastic
Colour: yellow fluid



BOX

Pack: nylon packaging
Pieces: 1 pcs



INSTALLATION EXAMPLE

As we know, the air conditioner leaking water is not fault but it is normal for the condensate drain of the conditioner due to the hot and cold air exchange with the radiator.

This range of accessories for the collection and drainage of the condensate of the external air-conditioning unit, helps us to solve this need.



ESEMPIO DI INSTALLAZIONE

Come sappiamo, l'unità esterna di condizionamento che gocciola acqua non è rotta ma è il normale scarico della condensa causato dello scambio di aria calda e fredda con il radiatore.

Questa gamma di accessori per la raccolta e lo scarico della condensa dell'unità di climatizzazione esterna, ci aiuta a sistemare questo inconveniente.





CONDENSATE DRIP TRAY

Code: VS110
Dimension: 830x310mm

Code: VS 210
Dimension: 1000x410mm



BRACKET FOR DRIP TRAY

Code: VS120
Description: use with VS110

Code: VS 220
Description: use with VS210



FLOOR SUPPORT FOR DRIP TRAY

Code: VS130
Description: use with VS110

Code: VS 230
Description: use with VS210



MATERIALS AND TREATMENT

Material: electro-galvanised steel
Treatment: epoxy resins in polyester for outdoor
Colour: Ral 9002



MATERIALS AND TREATMENT

Material: electro-galvanised steel
Treatment: epoxy resins in polyester for outdoor
Colour: Ral 9002



MATERIALS AND TREATMENT

Material: electro-galvanised steel
Treatment: epoxy resins in polyester for outdoor
Colour: Ral 9002



BOX

Pack: nylon packaging
Pieces: 1 piece



BOX

Pack: nylon packaging
Pieces: 1 couple



BOX

Pack: nylon packaging
Pieces: 1 couple



DIMENSIONS



DIMENSIONS

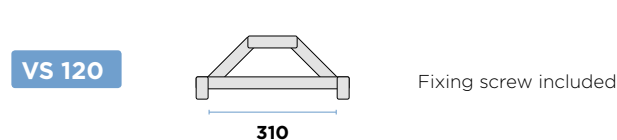

DIMENSIONS





Y 1616

UNIVERSAL FITTING FOR CONDENSATE DRAINING PIPE

GENERAL DATA

Input diameter: 16
Output diameter: 16
UVA resistant
Resistant to -20°C / +40°C

BOX

Pack: Nylon blister
Pieces per blister: 10
Blister per case: 10

Y 1620

UNIVERSAL FITTING FOR CONDENSATE DRAINING PIPE

GENERAL DATA

Input diameter: 16
Output diameter: 20
UVA resistant
Resistant to -20°C / +40°C

BOX

Pack: Nylon blister
Pieces per blister: 10
Blister per case: 10

Y 2020

UNIVERSAL FITTING FOR CONDENSATE DRAINING PIPE

GENERAL DATA

Input diameter: 20
Output diameter: 20
UVA resistant
Resistant to -20°C / +40°C

BOX

Pack: Nylon blister
Pieces per blister: 10
Blister per case: 10

Y 105

UNIVERSAL FITTING FOR CONDENSATE DRAINING PIPE

GENERAL DATA

Input diameter: 16/18/20
Output diameter: 16/18/20
UVA resistant
Resistant to -20°C / +40°C
Available accessories:
TSM 68/80 Metric drainage hose
TU 16/18/20 Drainage hose

BOX

Pack: Nylon blister
Pieces per blister: 10
Blister per case: 10
Case dimension: 250x350x150
Pack average weight: 2 Kg



TU



TSM

TU

SPIRAL CONDENSATE DRAINPIPE



GENERAL DATA

Smooth inside

Resistant to -20°C / +40°C

(lab tests, no changes after 72 hours)

Available accessories:

Y 105 Y universal pipe fitting

Y 1616 pipe fitting

Y1620 pipe fitting

Y 2020 pipe fitting



BOX

Pack: roll

Meters: 30

Roll average dimension: 400x400x200 mm

Pack average weight: 2.3 Kg

TSM

SPIRAL DRAINPIPE BY THE METER



GENERAL DATA

Wrinkler

Resistant to -10°C / +40°C

Available accessories:

Y 105 Y universal pipe fitting



BOX

Pack: carton box

Meters: 50

Pack dimension: 400x400x200 mm

Pack average weight: 2.3 Kg



PALLET

Pallet dimensions: 120x80x100 cm

Rolls per pallet: 30

Total pallet weight: 100 kg



PALLET

Pallet dimensions: 120x80x100 cm

Rolls per pallet: 24

Total pallet weight: 100 kg



TECHNICAL DATA

- Power supply: 220 - 240V AC < 16W
Alternative voltages available
- 1PH 50/60 Hz
- 3A volt-free Alarm wires, N/O N/C contacts
- Non-continuously rated - operating time:
5 mins on / 5 mins off
- Class 1 appliance
- Hall effect semi conductor level sensor
- Water flow rate:
14 litres per hr @ zero head
- Maximum water temperature: 40°C
- Maximum recommended head: 8m
- Sound level: 21dB(A) @ 1m & 8m head
- Suction lift: 1m
- Discharge tube: 6mm i/d
- CE marked
- Thermally protected
- Fully potted

SIUTABILTY

- Up to 16 kW / 54,000 Btu/h
- Ducted units; Floor standing & Chassis units;
High wall mini split systems
- Perfect for... Small & quiet - you'll never know
it's there!

KEY FEATURES

- Quietest in its class
- Acoustic damper
- Plug & play
- Anti siphon device

IN THE BOX

1. Assembled Mini Aqua pump
2. Assembled inline reservoir, including:
 - a) lid & sensor cable
 - b) float
 - c) filter
 - d) reservoir
3. 220mm x 19mm o/d x 14mm i/d inlet hose
4. 150mm x 9mm o/d x 6mm i/d vinyl tube
5. 1.5m x 9mm o/d x 6mm i/d vinyl tube
6. 2 x self adhesive velcro strips
7. 4 x 300mm x 3.6mm cable ties
8. 2 x 140mm x 3.6mm cable ties

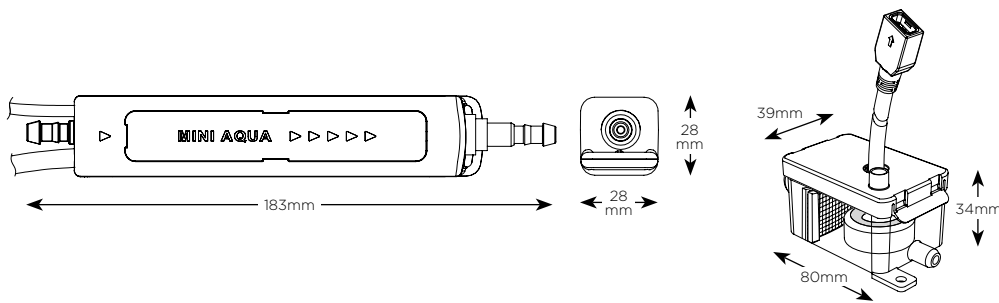

12L/h max. flow

**10m max. rec. head
(flow rate 6L/h)**

19 dB(A)

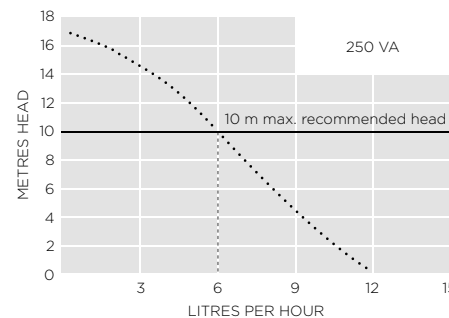

TECHNICAL DATA

- Power supply: 220 - 240V AC \leq 16W
 Alternative voltages available
- 1PH 50/60 Hz
- 3A volt-free Alarm wires, N/O N/C contacts
 rated @ 5A inductive at 220V - 240V AC
- Continuously rated
- Class 1 appliance
- Hall effect semi conductor level sensor
- Water flow rate: 14 litres per hr @ zero head
- Maximum water temperature: 40°C
- Maximum recommended head: 8 m
- Sound level: 23dB(A) @ 1 m & 8 m head
- Discharge tube: 6 mm i/d
- Max. pipe size (including insulation):
 Slimline: 3/8" & 5/8"
 Others: 5/8" & 3/4"
- CE marked
- Thermally protected
- Fully potted

SIUTABILITY

- Up to 16 kW / 54,000 Btu/h
- High wall split systems
- Perfect for... Commercial use where silence is important

KEY FEATURES

- Acoustic damper
- Pump sits in trunking elbow
- Left or right install
- Range of trunking system

IN THE BOX

1. Assembled Mini Lime pump, including:
 - a) 150 mm x 9 mm o/d breather tube
 - b) 6 mm o/d x 4 mm i/d green discharge tube with 6mm - 4mm reducing connector
2. Elbow back
3. Elbow front



 **12L/h max. flow**

 **10m max. rec. head
 (flow rate 6L/h)**

 **21 dB(A)**

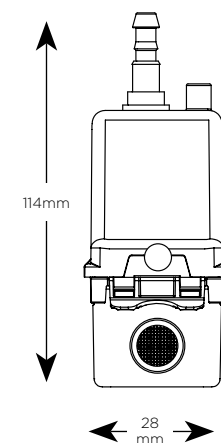
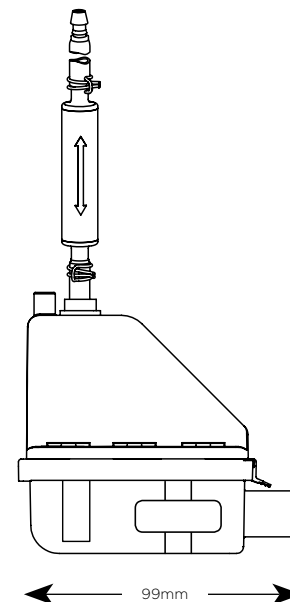
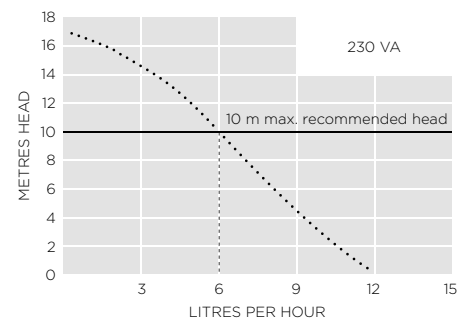

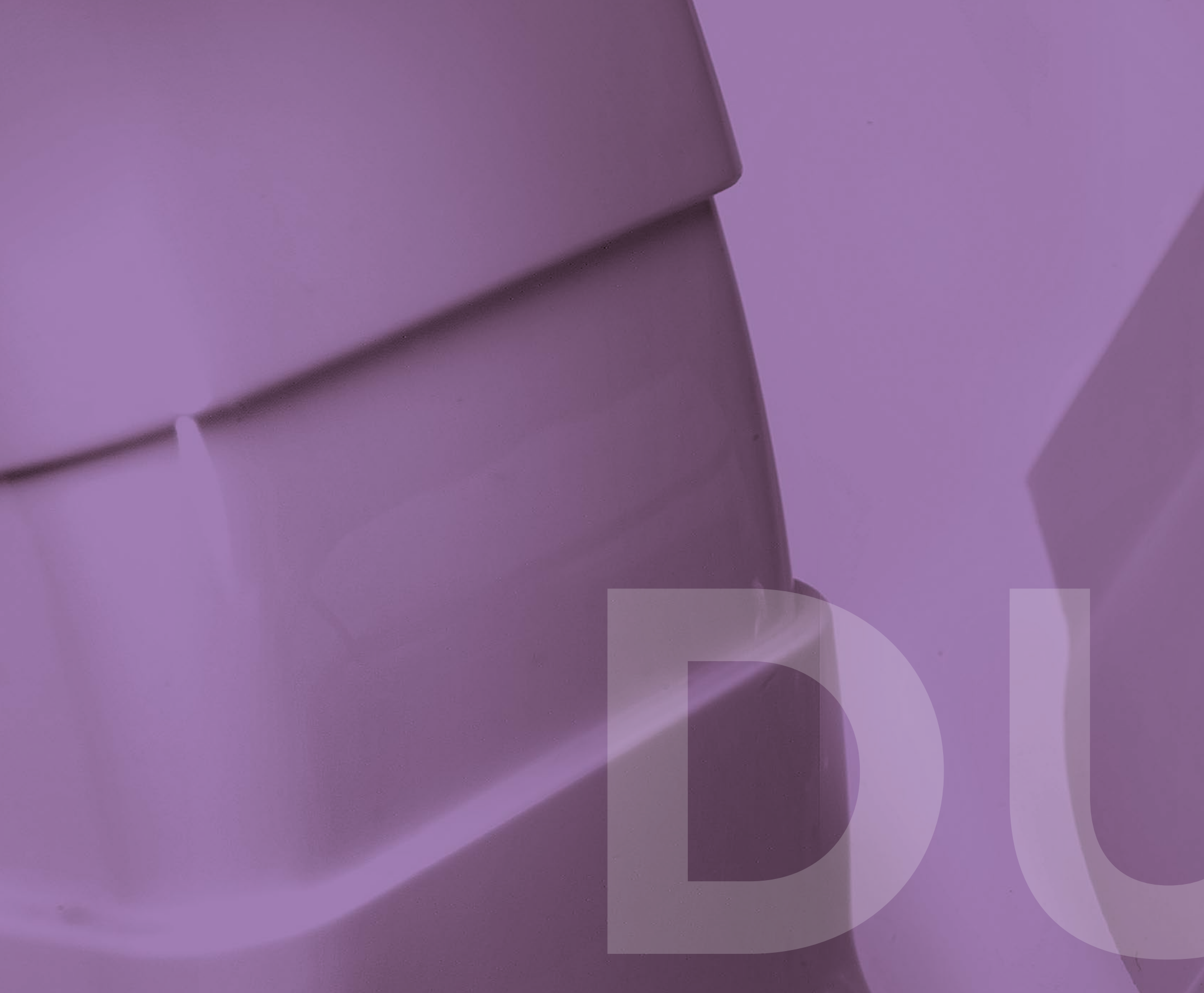

DUCTS

CANALINE

JUICERS



PRODUCT DESCRIPTION

Material: VO self-extinguishing PVC
Operating temperature: -20° +60° C



DIMENSIONS

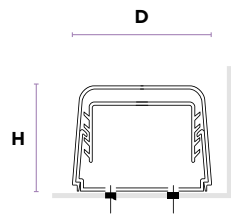

TYPE	L	H
BC 60	60	45
BC 80	80	60
BC 120	110	75

BM - BC

CODE	DESCRIPTION	BEARING CAPACITY	PACK SIZE
BC 60	Raceway base with lid of 2 ml. bars	1 ml	24 pcs
BC 80	Raceway base with lid of 2 ml. bars	1 ml	16 pcs
BC 120	Raceway base with lid of 2 ml. bars	1 ml	8 pcs

GF

CODE	DESCRIPTION	BEARING CAPACITY	PACK SIZE
GF 60	Flexible joint	1 pc	6 pcs
GF 80	Flexible joint	1 pc	4 pcs

CP

CODE	DESCRIPTION	BEARING CAPACITY	PACK SIZE
CP 60	Flat curve	1 pc	10 pcs
CP 80	Flat curve	1 pc	8 pcs
CP 120	Flat curve	1 pc	6 pcs

DT

CODE	DESCRIPTION	BEARING CAPACITY	PACK SIZE
DT 80	T diversion	1 pc	4 pcs
DT 120	T diversion	1 pc	2 pcs

AI

CODE	DESCRIPTION	BEARING CAPACITY	PACK SIZE
AI 60	90° external angle	1 pc	8 pcs
AI 80	90° external angle	1 pc	6 pcs
AI 120	90° external angle	1 pc	4 pcs

AE

CODE	DESCRIPTION	BEARING CAPACITY	PACK SIZE
AE 60	90° external angle	1 pc	12 pcs
AE 80	90° external angle	1 pc	9 pcs
AE 120	90° external angle	1 pc	6 pcs

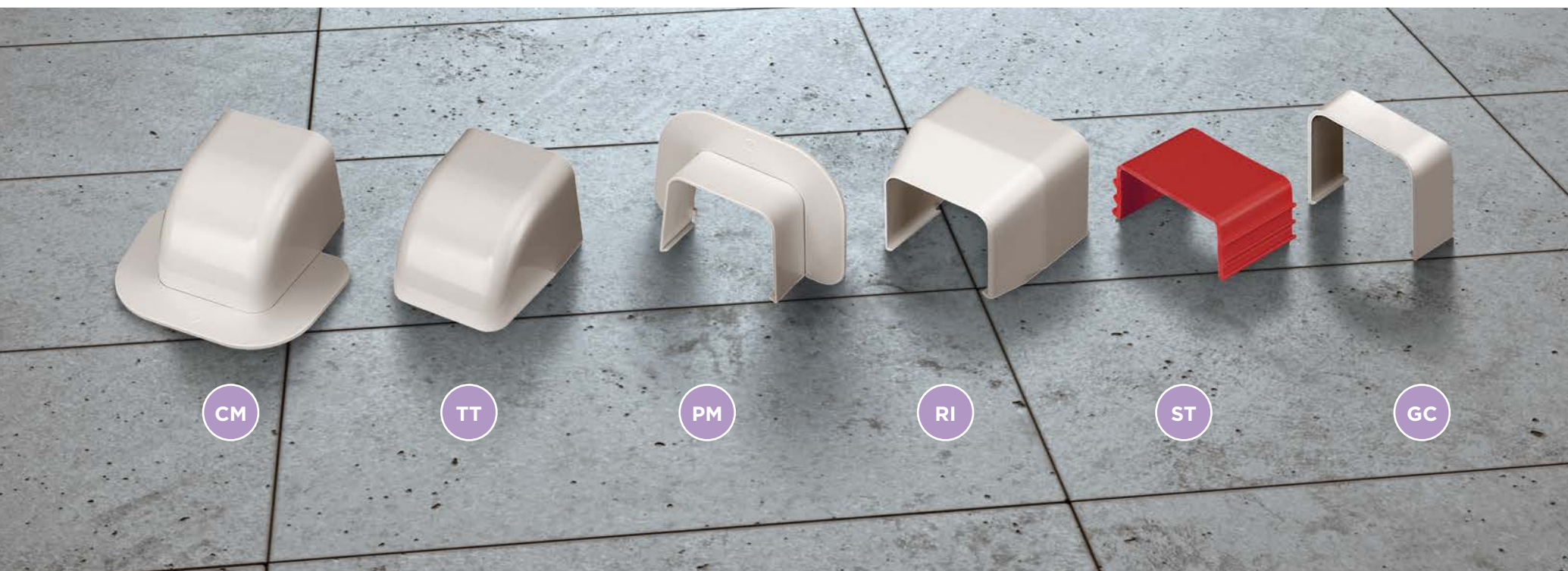

CM

CODE	DESCRIPTION	BEARING CAPACITY	PACK SIZE
CM 60	Wall curve	1 pc	9 pcs
CM 80	Wall curve	1 pc	6 pcs
CM 120	Wall curve	1 pc	4 pcs

TT

CODE	DESCRIPTION	BEARING CAPACITY	PACK SIZE
TT 60	Terminal plug	1 pc	12 pcs
TT 80	Terminal plug	1 pc	9 pcs

PM

CODE	DESCRIPTION	BEARING CAPACITY	PACK SIZE
PM 60	Wall passage	1 pc	10 pcs
PM 80	Wall passage	1 pc	8 pcs

RI

CODE	DESCRIPTION	BEARING CAPACITY	PACK SIZE
RI 60	Reduction	1 pc	12 pcs
RI 80	Reduction	1 pc	8 pcs

ST

CODE	DESCRIPTION	BEARING CAPACITY	PACK SIZE
ST 60	Pipe fixing brackets	1 pc	30 pcs
ST 80	Pipe fixing brackets	1 pc	30 pcs
ST 120	Pipe fixing brackets	1 pc	20 pcs

GC

CODE	DESCRIPTION	BEARING CAPACITY	PACK SIZE
GC 60	Lid joint	1 pc	30 pcs
GC 80	Lid joint	1 pc	30 pcs
GC 120	Lid joint	1 pc	20 pcs

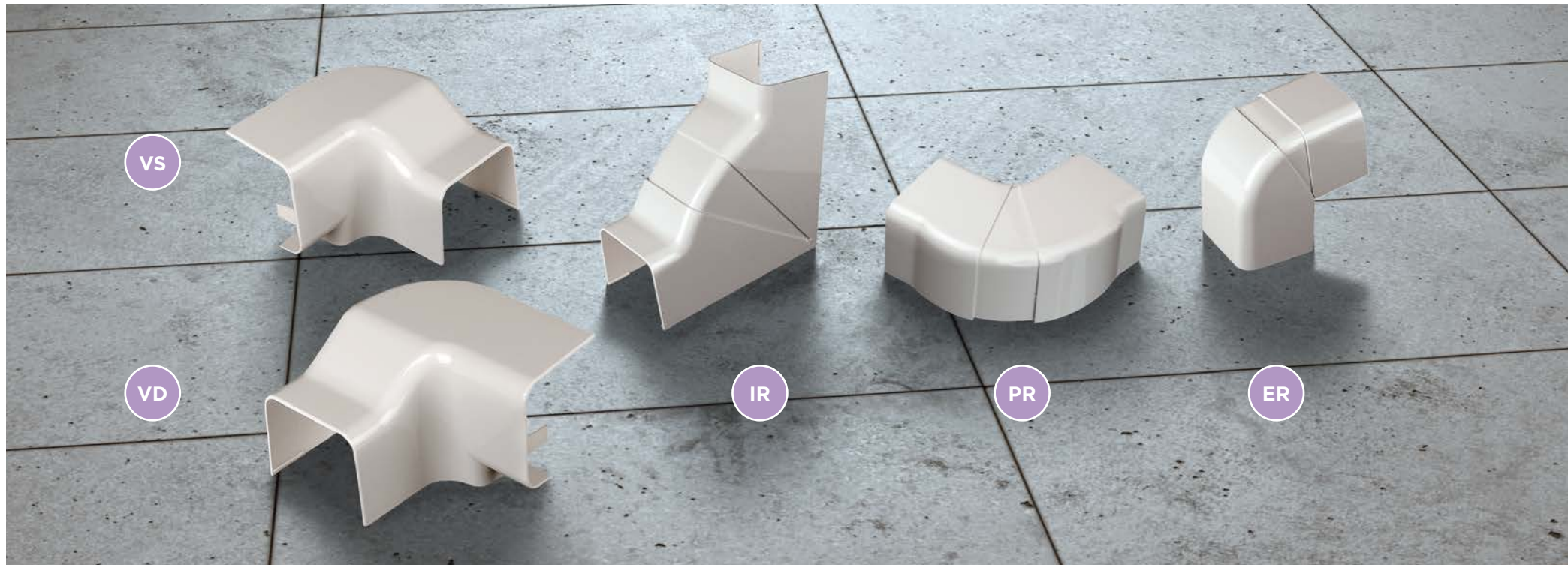

PRODUCT DESCRIPTION

Material: VO self-extinguishing PVC

Operating temperature: -20° +60° C

VS

CODE	DESCRIPTION	PACK SIZE
VS 60-80	Left vertical angle	4 pcs

VD

CODE	DESCRIPTION	PACK SIZE
VD 60-80	Right vertical angle	4 pcs

IR

CODE	DESCRIPTION	PACK SIZE
IR 60-80	Adjustable internal angle 80°-105°	4 pcs

PR

CODE	DESCRIPTION	PACK SIZE
PR 60-80	Adjustable plane curve 65°-130°	6 pcs

ER

CODE	DESCRIPTION	PACK SIZE
ER 60-80	Adjustable external angle 70°-120°	8 pcs

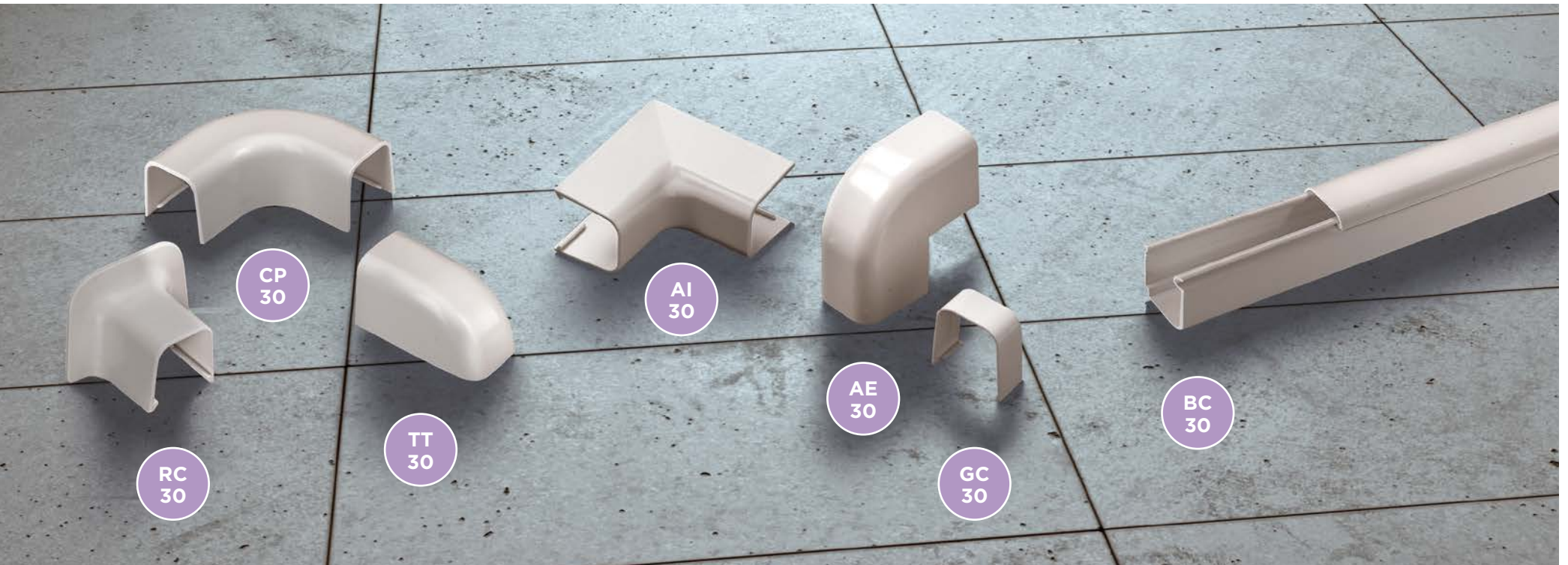

RC30

CODE	DESCRIPTION	PACK SIZE
RC30	Reduced connection	20 pcs

CP30

CODE	DESCRIPTION	PACK SIZE
CP30	Flat curve	20 pcs

TT30

CODE	DESCRIPTION	PACK SIZE
TT30	Terminal plug	20 pcs

AI30

CODE	DESCRIPTION	PACK SIZE
AI30	90° internal angle	20 pcs

AE30

CODE	DESCRIPTION	PACK SIZE
AE30	90° external angle	20 pcs

GC30

CODE	DESCRIPTION	PACK SIZE
GC30	Lid joint	20 pcs

BC30

CODE	DESCRIPTION	PACK SIZE
BC30	Duct with envelopping top	2 m



PRODUCT DESCRIPTION

Duct for introduction of drainage tubes

Material: VO self-extinguishing PVC

Operating temperature: -20° +60° C



ACCES



ACCESSORIES

ACCESSORI

SSORRIES



FS
400

FS
101

AC
101

FS
300

FS 400 FIXING KIT FOR DUCT

GENERAL DATA

Screw size: M5x35 self-tapping
Diameter: 12 mm crosshead
Block size: M6x30

BOX

Pack: thermoformed blister
Pieces: 300+300
Blister dimension: 250x210x40 mm

FS 101 FIXING KIT FOR SUPPORTS

GENERAL DATA

Screw size: M8X80 galvaized hexagonal head lag screw
Block size: M12x70
Washer size: M8x24

BOX

Pack: nylon blister
Pieces per pack: 4+4+4

AC 101 CHEMICAL ANCHORING KIT

GENERAL DATA

Bi-component chemical anchoring with gun adapter for silicon.

BOX

Pack: nylon blister
Pieces per pack:
1 adapter; 1 cartridges; 2 mixers

FS 300 FIXING KIT FOR CHEMICAL ANCHORING

GENERAL DATA

Screw size: threaded bar M8x120 + bolts and nuts
Block size: M8x80

BOX

Pack: nylon blister
Pieces: 4 series



FA 101
ADHESIVE INSULATING BAND

 **TECHNICAL CHARACTERISTICS**

Colour: black
Classification of reaction to fire: Class 1
Coefficient of thermal conductivity at 0°C:
 λ 0,034
Steam diffusion resistance coefficient: μ 11.268
Operating temperature: -40°C a +105°C
Thickness: 3 mm
Width: 50 mm
Length: 10 m

 **BOX**

Single packaging in transparent cellophane envelope

Carton pack: 43x43x21 cm
Pack content: 24 rolls

FA 102
ADHESIVE INSULATING BAND

 **TECHNICAL CHARACTERISTICS**

Colour: white
Classification of reaction to fire: Class 1
Coefficient of thermal conductivity at 0°C:
 λ 0,034
Steam diffusion resistance coefficient: μ 11.268
Operating temperature: -40°C a +105°C
Thickness: 3 mm
Width: 50 mm
Length: 10 m

 **BOX**

Single packaging in transparent cellophane envelope

Carton pack: 43x43x21 cm
Pack content: 24 rolls

CPR
TAPS COVER

 **BOX**

Pack: blister in nylon
Pieces per blister: 10 Pcs
Multi-pack: carton box
Blister per case: 100 Pcs

FA 102
TAPS COVER

 **PRODUCT DESCRIPTION**

CT 001 small
CT 002 medium
CT 003 large
CT 004 extralarge

Protective cover for external air-conditioning units when not operating

 **BOX**

Pack: Plastic Blister
Pieces: 1
Blister dimension: 230x230x40 mm

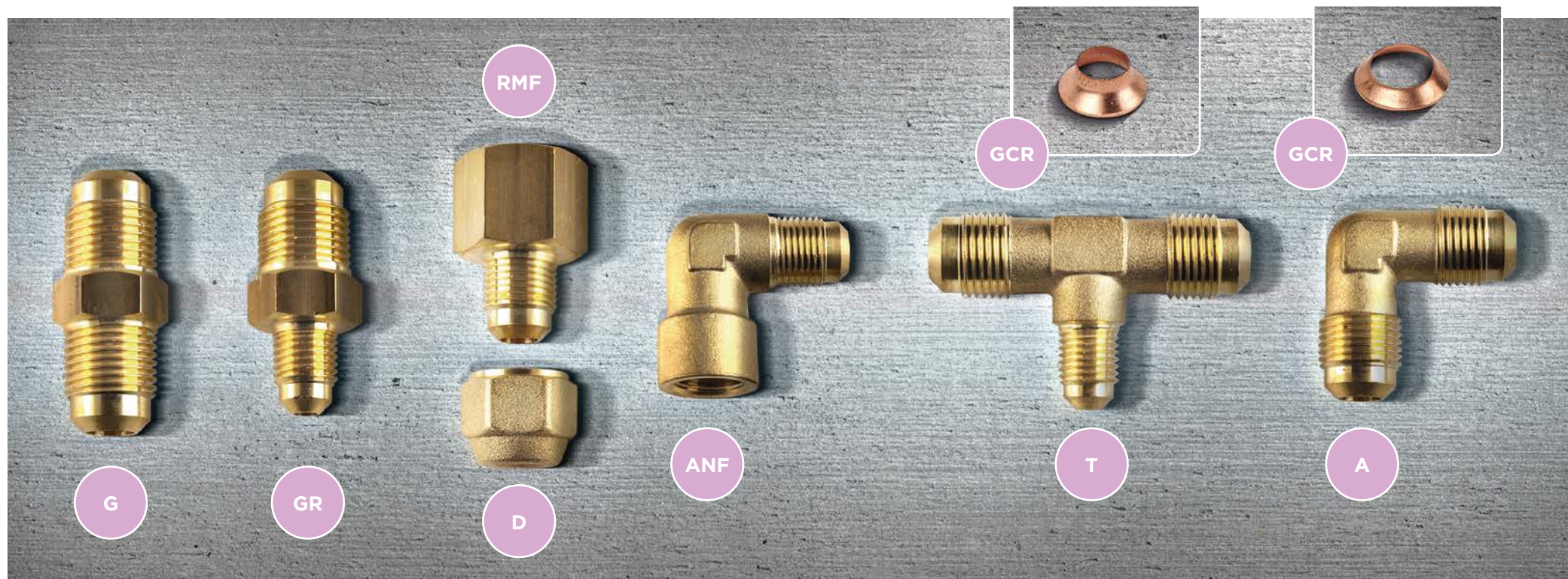

GASKETS

CODE	DESCRIPTION
GCR 14	Gasket 1/4"
GCR 38	Gasket 3/8"
GCR 12	Gasket 1/2"
GCR 58	Gasket 5/8"

JOINT

CODE	DESCRIPTION
G 14	Pipe joint for 1/4" pipes
G 38	Pipe joint for 3/8" pipes
G 12	Pipe joint for 1/2" pipes
G 58	Pipe joint for 5/8" pipes
G 34	Pipe joint for 3/4" pipes

PIPES UNIONS

CODE	DESCRIPTION
D 14	Pipe union for 1/4" pipes
D 38	Pipe union for 3/8" pipes
D 12	Pipe union for 1/2" pipes
D 58	Pipe union for 5/8" pipes
D 34	Pipe union for 3/4" pipes

COPPER CONICAL GASKET

CODE	DESCRIPTION
GLR 14	Copper conical gasket 1/4"
GLR 38	Copper conical gasket 3/8"
GLR 12	Copper conical gasket 1/2"
GLR 58	Copper conical gasket 5/8"

REDUCED JOINTS

CODE	DESCRIPTION
GR 1438	Reduced joint for 1/4" x 3/8" pipes
GR 1412	Reduced joint for 1/4" x 1/2" pipes
GR 3812	Reduced joint for 3/8" x 1/2" pipes

REDUCTIONS

CODE	DESCRIPTION
RMF 3814	Male-female reduction 3/8"m x 1/4"f
RMF 1238	Male-female reduction 1/2"m x 3/8"f
RMF 5812	Male-female reduction 5/8"m x 1/2"f
RMF 1438	Male-female reduction 1/4"m x 3/8"f
RMF 3812	Male-female reduction 3/8"m x 1/2"f
RMF 1258	Male-female reduction 1/2"m x 5/8"f

MATERIALS AND TREATMENT

Adjustable patented equipment for installing brackets + magnetic level



PACKA

SPECIAL PACKAGING

IMBALLI SPECIALI

AGGING



WE DEVELOP YOUR IDEAS

Thanks to an integrated management of the whole production cycle, from the transformation of the raw material to the final packaging, we are able to realize a personalized product which satisfies your needs.



SVILUPPIAMO LE VOSTRE IDEE

Grazie ad una gestione integrata dell'intero ciclo produttivo, dalla trasformazione della materia prima al confezionamento finale, siamo in grado di realizzare un prodotto personalizzato che corrisponda alle vostre esigenze.





Rodigas reserves the right to change the products shown in the catalogue at any moment, without prior notice. All the data given herein are purely indicative and not binding.

Rodigas srl si riserva di apportare variazioni ai prodotti del presente catalogo, in qualsiasi momento, anche senza preavviso. Tutti i dati qui riportati sono indicativi e non vincolanti.

Design by
yakagency.com

Company Profile by
giallobanana.it

Illustration by
alegiorgini.com



Rodigas S.r.l.
via Giacomelli, 10
35010 Limena (PADOVA) ITALY
Tel. +39 049 8840056 r.a.
Fax +39 049 8840060
E-mail: info@rodigas.it
www.rodigas.it



La nostra attenzione all'ambiente ci ha spinto a stampare questo catalogo con marchio FSC, che identifica tutti i prodotti contenenti legno provenienti da foreste gestite in maniera responsabile secondo rigorosi standard ambientali, sociali ed economici.