

AXIAL FANS



B6PA

AC WALL MOUNTED AXIAL FANS Plastic Blade

Propellers are manufactured in ideal dimension and got maximum air flow. Designed to be installed directly into walls, ceiling or panels with it's square plate.

Technical Drawings

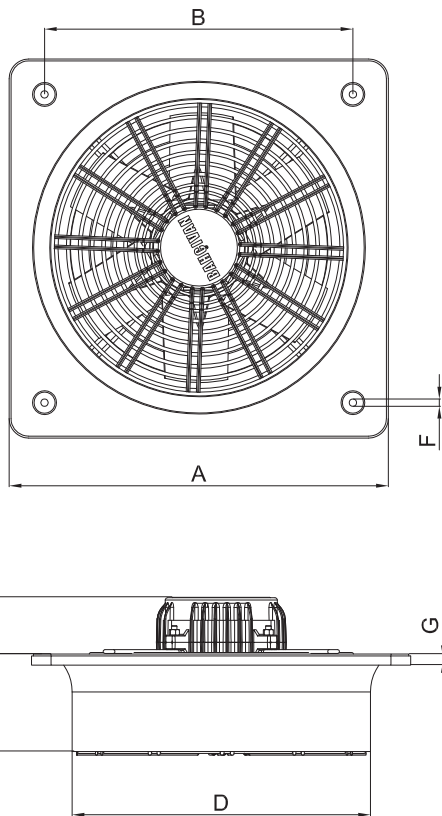

MATERIAL

: The casing is made of electrostatic powder coated sheet metal, impeller is made of plastic.

INSULATION CLASS

: Class B and Class F

DIRECTIVE

: EN 60335-1, EN 60335-2-80

SPEED CONTROL

: Speed can be adjusted using an optional controller.

APPLICATION AREAS

: Factories, stock depots, dye-houses, shopping centers, big halls, etc.

Accessories



BSC

TYPE	VOLTAGE	FREQUENCY	POWER	CURRENT	CAPACITOR	SPEED	AIR FLOW	SOUND PRESSURE LEVEL	WEIGHT
	V	Hz	W	(A)	(μ F)	d/d	m ³ /h	dB(A)	kg
B6PAM 250/B6PAT 250	230	50	190	1,1	8/-	1475	1500	60	7.3
B6PAM 300/B6PAT 300	230	50	210	1,1	8/-	1445	2390	60	8.5
B6PAM 350/B6PAT 350	230	50	270	1,3	8/-	1400	4080	63	9.9
B6PAM 400/B6PAT 400	230	50	310	1,4	8/-	1350	5200	65	10.4
B6PAM 450/B6PAT 450	230	50	360	1,6	8/-	1240	6100	63	11.4
B6PAM 500/B6PAT 500	230	50	440	2	8/-	1130	7200	68	13.6

TYPE	A	B	C	D	E	F	G
B6PA 250	333	275	80	261	80	8.25	10
B6PA 300	412	336	80	307	80	8.25	10
B6PA 350	465	390	90	365	80	8.25	10
B6PA 400	500	420	100	403	80	8.25	10
B6PA 450	560	480	105	462	80	8.25	10
B6PA 500	630	561	110	513	90	8.25	10

Dimensions are in (mm)

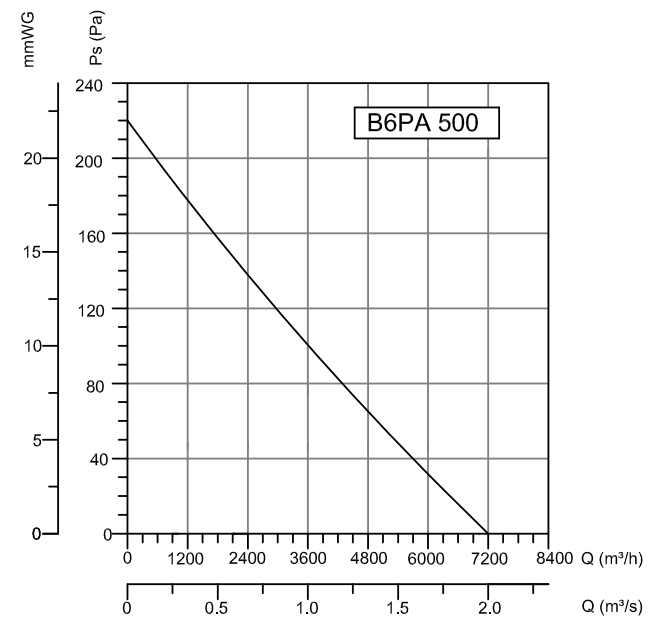
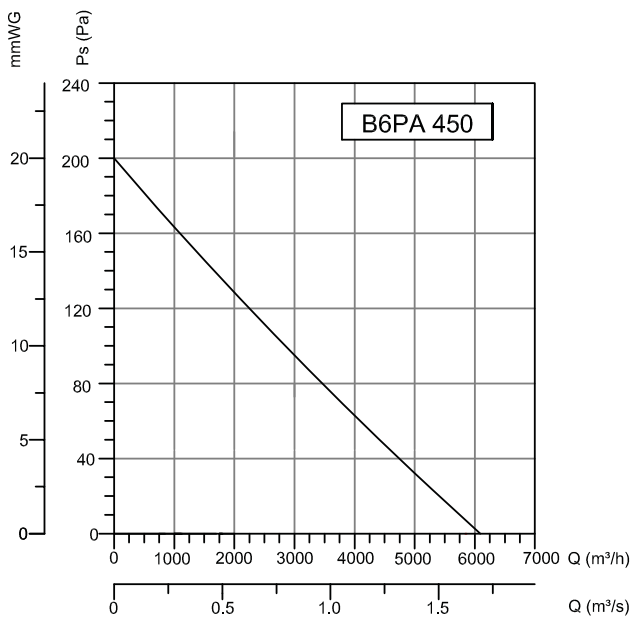
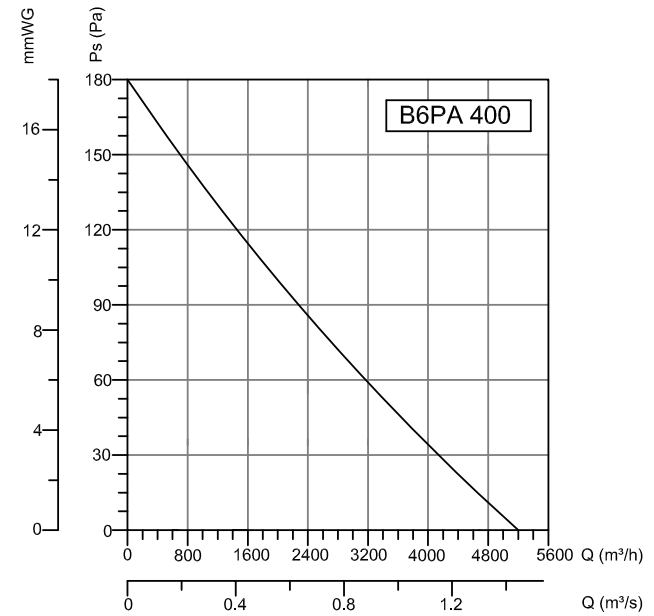
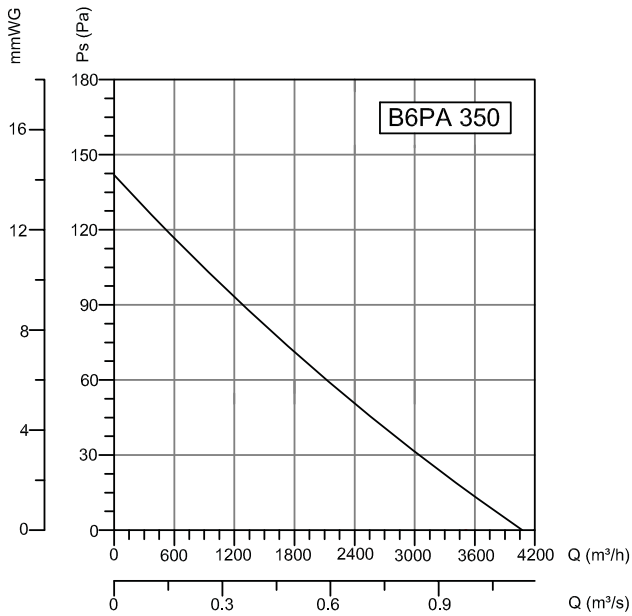
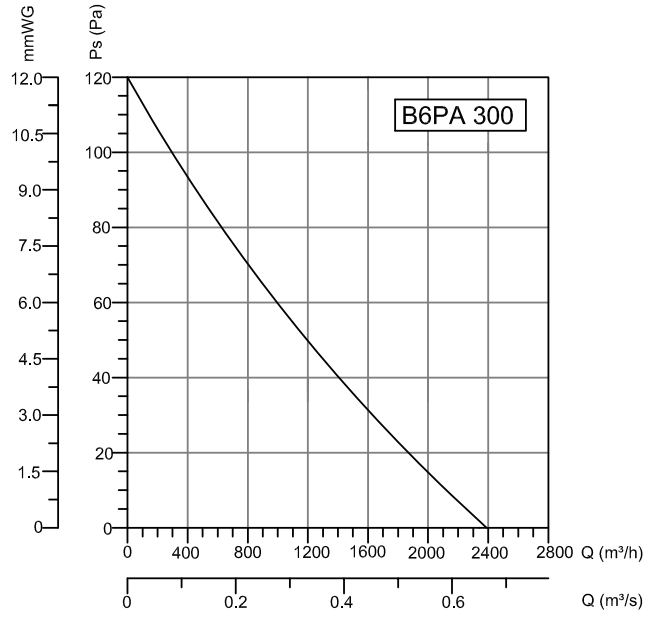
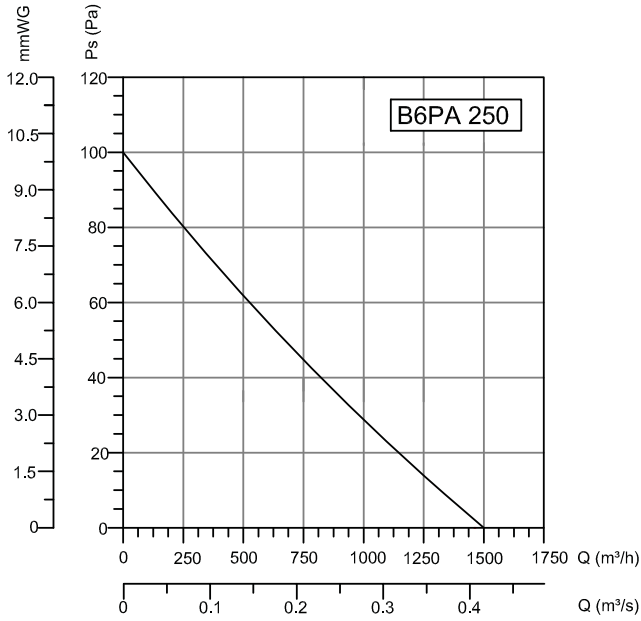

DUCT FANS

ROOF FANS

AXIAL FANS

RADIAL FANS

PLASTIC FANS

VENTILATORS

SMOKE EXHAUST SYSTEMS

ACCESSORIES